

Fuller Mid-Range Transmissions TRSM0180

October 2007

FS-7206A



Powering Business Worldwide

BACKED BY

Roadranger

SUPPORT

WARNING

Before starting a vehicle always be seated in the drivers seat, place the transmission in neutral, set the parking brakes and disengage the clutch.

Before working on a vehicle place the transmission in neutral, set the parking brakes and block the wheels.

Before towing the vehicle place the transmission in neutral, and lift the rear wheels off the ground or disconnect the driveline to avoid damage to the transmission during towing.

TABLE OF CONTENTS

FOREWORD

MODEL DESIGNATIONS AND SPECIFICATIONS

LUBRICATION.

OPERATION

POWER FLOW

TORQUE RECOMMENDATIONS

PREVENTIVE MAINTENANCE

P R E C A U T I O N S

DISASSEMBLY

INSPECTION

REASSEMBLY

DISASSEMBLY AND REASSEMBLY–SHIFTING CONTROLS

GEARSHIFT LEVER HOUSING ASSEMBLY

SHIFT BAR HOUSING ASSEMBLY

REMOVAL – OUTPUT YOKE AND CLUTCH HOUSING

DISASSEMBLY – TRANSMISSION

REASSEMBLY – TRANSMISSION

INSTALLATION–CLUTCH HOUSING AND OUTPUT YOKE

INSTALLATION–SHIFTING CONTROLS

SHIFT BAR HOUSING ASSEMBLY

GEARSHIFT LEVER HOUSING ASSEMBLY

FOREWORD

This manual is designed to provide detailed information necessary to service and repair the Eaton® Fuller® Transmission listed on the cover.

As outlined in the Table of Contents, the manual is divided into 3 main sections:

- a. Technical information and reference
- b. Removal, disassembly, reassembly and installation
- c. Options

The format of the manual is designed to be followed in its entirety if complete disassembly and reassembly of the transmission is necessary. But if only one component of the transmission needs to be repaired, refer to the Table of Contents for the page numbers showing that component. For example, if you need to work on the Shift Bar Housing, you will find instructions for removal, disassembly and reassembly on page 18. Instructions for installation are on page 62. Service Manuals, Illustrated Parts Lists, Drivers Instructions, and other forms of product

service information for these and other Fuller Transmissions are available upon request. A Technical Literature Order Form may be found in the back of this manual*. You may also obtain Service Bulletins, detailing information on product improvements, repair procedures and other service-related subjects by writing to the following address:

EATON CORPORATION
TRANSMISSION DIVISION
Technical Service Department
P.O. Box 4013
Kalamazoo, Michigan 49003
(61 6) 342-3344

***Note to Canadian Residents:**

Please do not use the order form in the back of this manual. A special Canadian Product Literature Order Form may be obtained by contacting the following:

EATON CORPORATION
TRANSMISSION DIVISION
P.O. Box 1368
Benton Harbor, MI 49022
(61 6) 342-3344

MODEL DESIGNATIONS AND SPECIFICATIONS

Nomenclature:

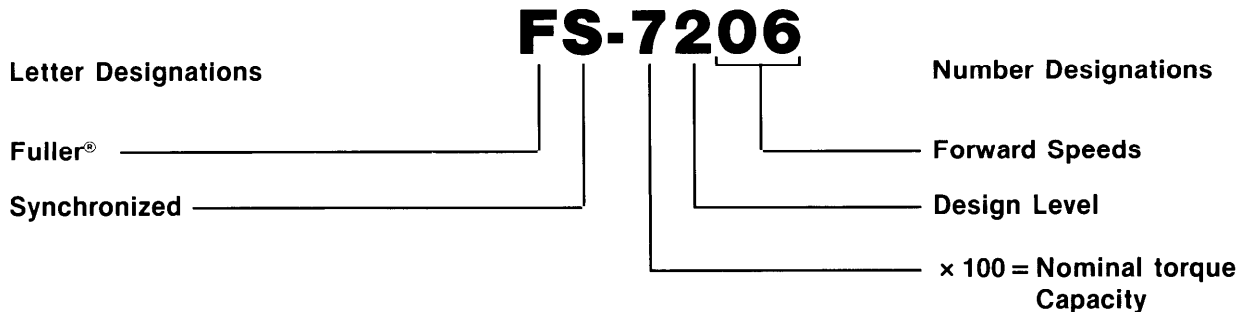

IMPORTANT: All Eaton Fuller Transmissions are identified by model and serial number. This information is stamped on the transmission identification tag and affixed to the case. DO NOT REMOVE OR DESTROY THE TRANSMISSION IDENTIFICATION TAG.

Specifications:

Model	No. Speeds	Gear Ratios							Relative Speed PTO Gear to Input R PM		Note 1 Length In. (mm)	Note 2 Weight Lbs (Kg.)	Note 3 Oil Capacity Pints (Liters)
		1st	2nd	3rd	4th	5th	6th	Reverse	Left	Right			
FS-7206	6	9.00	4.98	2.98	1.89	1.32	1.00	800	455	455	28.47 (723.1)	392 (177.8)	21 (10.0)

See Chart Notes.

CHART NOTES:

1. Lengths measured from face of clutch housing to rear of speedo gear.
2. Weights include shift bar housing and end yoke, clutch housing, less tower assembly and clutch release parts. For more information on available clutch housings, refer to the transmission's Illustrated Parts List or the Super Parts Book. All weights are approximate.
3. Oil capacities are approximate, depending on inclination of engine and transmission. Always fill transmission with proper grade and type of lubricant to level of filler opening. See LUBRICATION.

LUBRICATION

Proper Lubrication . . . the Key to long transmission life

Proper lubrication procedures are the key to a good all-around maintenance program. If the 011 is not doing its job, or if the oil level is ignored, all the maintenance procedures in the world are not going to keep the transmission running or assure long transmission life.

Eaton® Fuller® Transmissions are designed so that the internal parts operate in a bath of 011 circulated by the motion of gears and shafts.

Thus, all parts will be amply lubricated if these procedures are closely followed:

1. Maintain oil level. Inspect regularly.
2. Change oil regularly.
3. Use the correct grade and type of oil.
4. Buy from a reputable dealer.

Lubrication Change and Inspection

Eaton® Roadranger® CD50 Transmission Fluid	
HIGHWAY USE — Heavy Duty and Mid-Range	
First 3,000 to 5000 miles (4827 to 8045 Km)	Factory fill Initial drain
Every 10,000 miles (16090 Km)	Check fluid level Check for leaks
Heavy Duty Highway Change Interval	
Every 250,000 miles (402336 Km)	Change transmission fluid
Mid-Range Highway Change Interval	
Every 100,000 miles (160,000 Km) or every 3 years whichever occurs first	Change transmission fluid
OFF. HIGHWAY USE	
First 30 hours	Factory fill initial drain
Every 40 hours	Inspect fluid-level Check for leaks
Every 500 hours	Change transmission fluid where severe dirt conditions exist
Every 1,000 hours	Change transmission fluid (Normal off-highway use)
Heavy Duty Engine Lubricant or Mineral Gear Lubricant	
HIGHWAY USE	
First 3000 to 5000 miles (4827 to 8045 Km)	Factory fill Initial drain
Every 10000 miles (16090 Km)	Inspect lubricant level Check for leaks
Every 50,000 miles (80450 Km)	Change transmission lubricant
OFF-HIGHWAY USE	
First 30 hours	Change transmission lubricant on new units
Every 40 hours	Inspect lubricant level Check for leaks
Every 500 hours	Change transmission lubricant where severe dirt conditions exist
Every 1000 hours	Change transmission lubricant (Normal off-highway use)

Change the oil filter when fluid or lubricant is changed.

Recommended Lubricants		
Type	Grade (SAE)	Fahrenheit (Celsius) Ambient Temperature
Eaton® Roadranger® CD50 Transmission Fluid	50	All
Heavy Duty Engine Oil		
MIL-L-2104B, C or D or	50	Above 10°F (-12°C)
API-SF or API-CD	40	Above 10°F (-12°C)
(Previous API designations acceptable)	30	Below 10°F (-12°C)
Mineral Gear Oil with rust and oxidation inhibitor	90 80W	Above 10°F (-12°C) Below 10°F (-12°C)
API-GL-1		

The use of mild EP gear oil or multi-purpose gear oil is not recommended, but if these gear oils are used, be sure to adhere to the following limitations:

Do not use mild EP gear oil or multi-purpose gear oil when operating temperatures are above 230°F (110°C). Many of these gear oils, particularly 85W140, break down above 230°F and coat seals, bearings and gears with deposits that may cause premature failures. If these deposits are observed (especially a coating on seal areas causing oil leakage), change to Eaton Roadranger CD50 transmission fluid, heavy duty engine oil or mineral gear oil to assure maximum component life and to maintain your warranty with Eaton. (Also see "Operating Temperatures".)

Additives and friction modifiers are not recommended for use in Eaton Fuller transmissions.

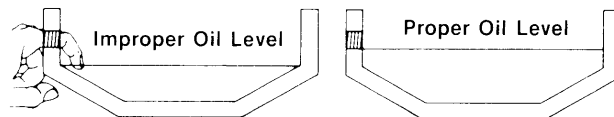

Proper Oil Level

Make sure oil is level with filler opening. Because you can reach oil with your finger does not mean oil is at proper level, **One inch of oil level is about one gallon of oil.**

Draining Oil

Drain transmission while oil is warm. To drain oil remove the drain plug at bottom of case. Clean the drain plug before re-installing.

Refilling

Clean case around filler plug and remove plug from side of case. Fill transmission to the level of the filler opening. If transmission has two filler openings, fill to level of both openings.

The exact amount of oil will depend on the transmission inclination and model. Do not over fill—this will cause oil to be forced out of the transmission.

When adding oil, types and brands of oil should not be mixed because of possible incompatibility.

LUBRICATION

Operating Temperatures —With Eaton® Roadranger® CD50 Transmission Fluid Heavy Duty Engine Oil and Mineral Oil

The transmission should not be operated consistently at temperatures above 250°F (120°C). However, intermittent operating temperatures to 300°F (149°C) will not harm the transmission. Operating temperatures above 250°F increase the lubricant's rate of oxidation and shorten its effective life. When the average operating temperature is above 250°F, the transmission may require more frequent oil changes or external cooling.

The following conditions in any combination can cause operating temperatures of over 250°F: (1) operating consistently at slow speeds, (2) high ambient temperatures, (3) restricted air flow around transmission, (4) exhaust system too close to transmission, (5) high horsepower, overdrive operation.

External oil coolers are available to reduce operating temperatures when the above conditions are encountered.

Transmission Oil Coolers are:

Recommended

- With engines of 350 H.P. and above with overdrive transmissions

Required

- With engines 399 H.P. and above with overdrive transmissions and GCW'S over 90,000 lbs.
- With engines 399 H.P. and above and 1400 Lbs.-Ft. or greater torque
- With engines 450 H.P. and above

— With EP or Multipurpose Gear Oil

Mild EP gear oil and multipurpose gear oil are not recommended when lubricant operating temperatures are above 230°F (110°C). In addition, transmission oil coolers are not recommended with these gear oils since the oil cooler materials may be attacked by these gear oils. The lower temperature limit and oil cooler restriction with these gear oils generally limit their success to milder applications.

Proper Lubrication Levels as Related to Transmission Installation Angles

If the transmission operating angle is more than 12 degrees, improper lubrication can occur. The operating angle is the transmission mounting angle in the chassis plus the percent of upgrade (expressed in degrees).

The chart below illustrates the safe percent of upgrade on which the transmission can be used with various chassis mounting angles. For example: if you have a 4 degree transmission mounting angle, then 8 degrees (or 14 percent of grade) is equal to the limit of 12 degrees. If you have a 0 degree mounting angle, the transmission can be operated on a 12 degree (21 percent) grade.

Anytime the transmission operating angle of 12 degrees is exceeded for an extended period of time the transmission should be equipped with an oil pump or cooler kit to insure proper lubrication.

Note on the chart the effect low oil levels can have on safe operating angles. Allowing the oil level to fall 1/2" below the filler plug hole reduces the degree of grade by approximately 3 degrees (5.5 percent).

Proper Lubrication Levels are Essential!

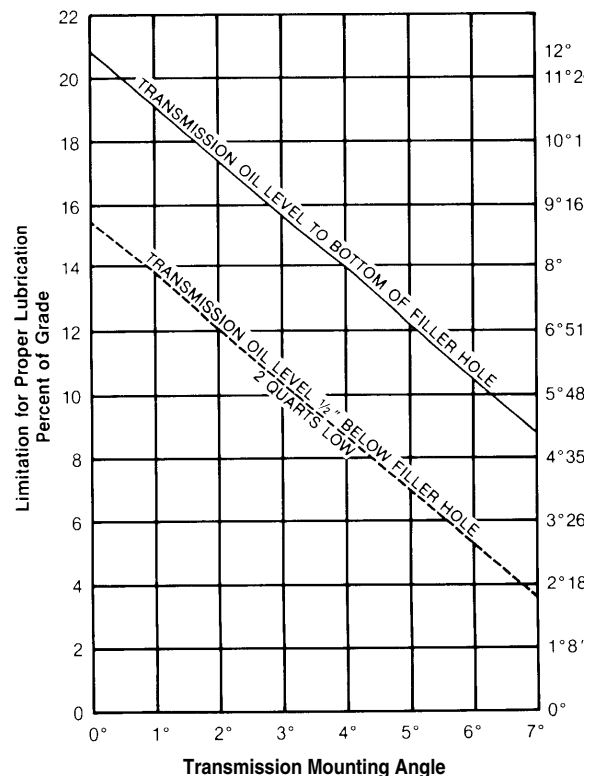

Dotted line showing "2 Quarts Low" is for reference only. Not recommended.

OPERATION

Gear Shift Lever Pattern and Shifting Instructions

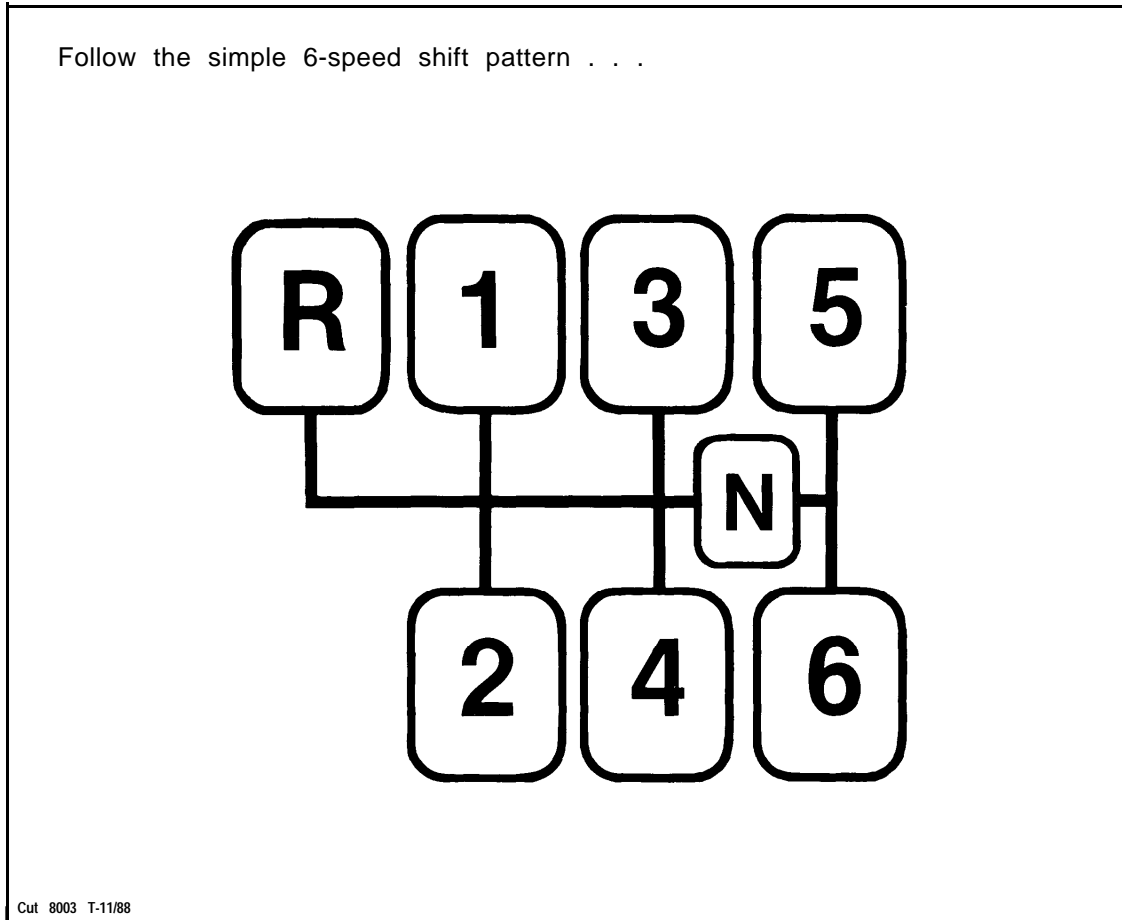

General Information

FS-7206A transmissions have six forward speeds and one reverse, and are shifted as you would shift any synchronized manual transmission, following the simple 6-speed shift pattern.

Driving Tips

- Always use the clutch when making upshifts or downshifts. Premature synchronizer failure can result from not using the clutch.
- Always select a starting gear that will provide sufficient reduction for the load and terrain.
- Do not double clutch upshifts or downshifts.
- Never downshift at too high of a road speed.
- Never slam or jerk the shift lever to complete gear engagement.
- Never coast with the transmission in neutral and the clutch dis-engaged.
- Although the FS-7206 transmission's first gear is synchronized, it is advised that a downshift into first gear be completed at very slow vehicle speed to prevent engine over speed.

POWER FLOW

The transmission must efficiently transfer the engine's power, in terms of torque, to the vehicle's rear wheels. Knowledge of what takes place in the transmission during torque transfer is essential when trouble-shooting and making repairs becomes necessary.

1. Power (torque) from the engine is transferred to the input shaft and drive gear.
2. Torque is transferred to the countershaft drive gear.
3. Torque is delivered along countershaft to all countershaft gears.
4. Torque is transferred to "engaged" mainshaft gear. The cross section illustrates 1st speed gear position.
5. Internal clutching teeth of engaged mainshaft gear transfers torque to mainshaft through synchronizer assembly.
6. Mainshaft transfers torque directly to driveshaft through rear yoke.

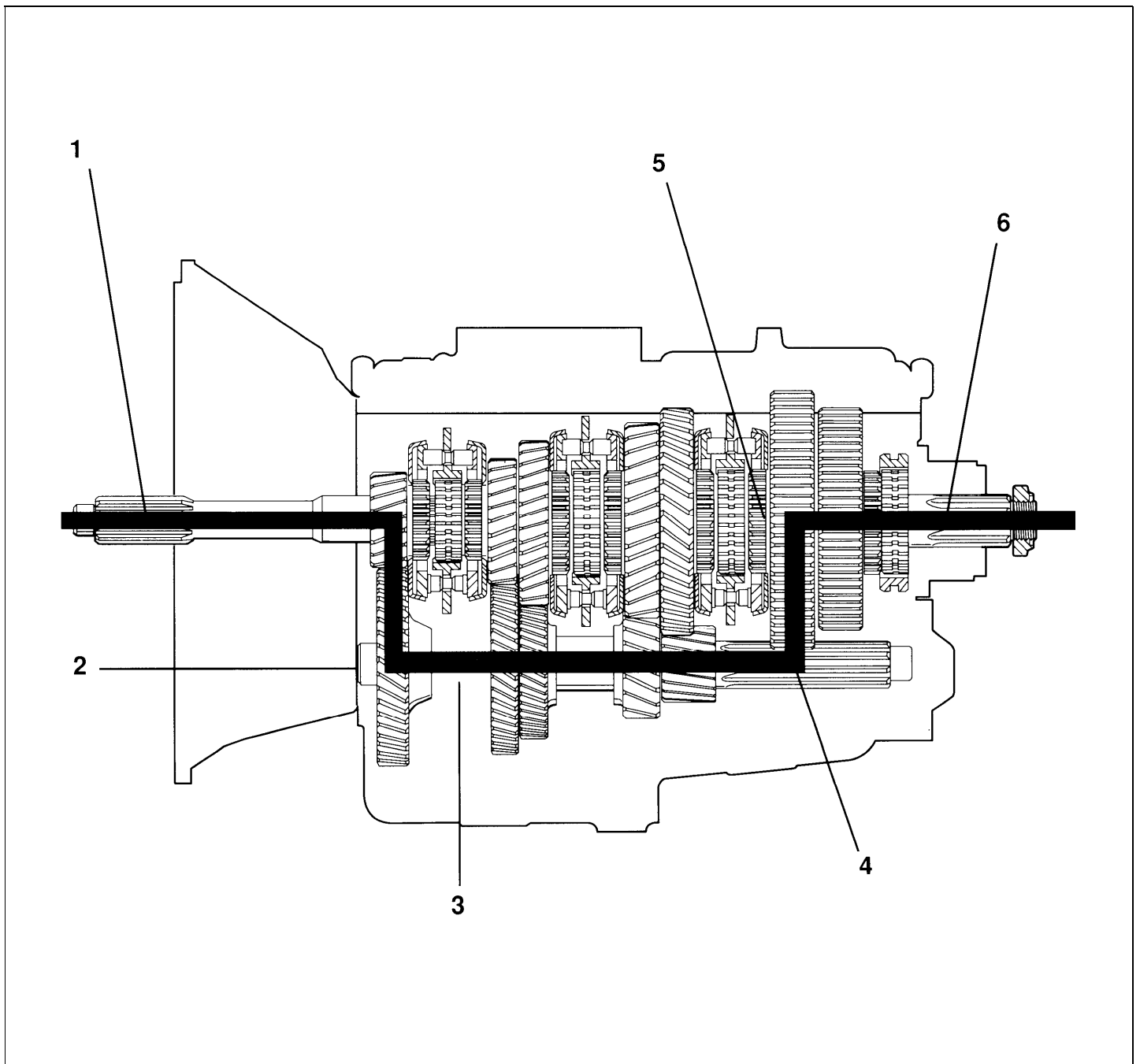

TORQUE RECOMMENDATIONS

Correct torque application is extremely important to assure long transmission life. Over-tightening or under-tightening of fasteners can result in a loose installation and, in many instances, eventually cause damage to the transmission. Use a torque wrench to attain recommended torque ratings. Do not torque capscrews dry.

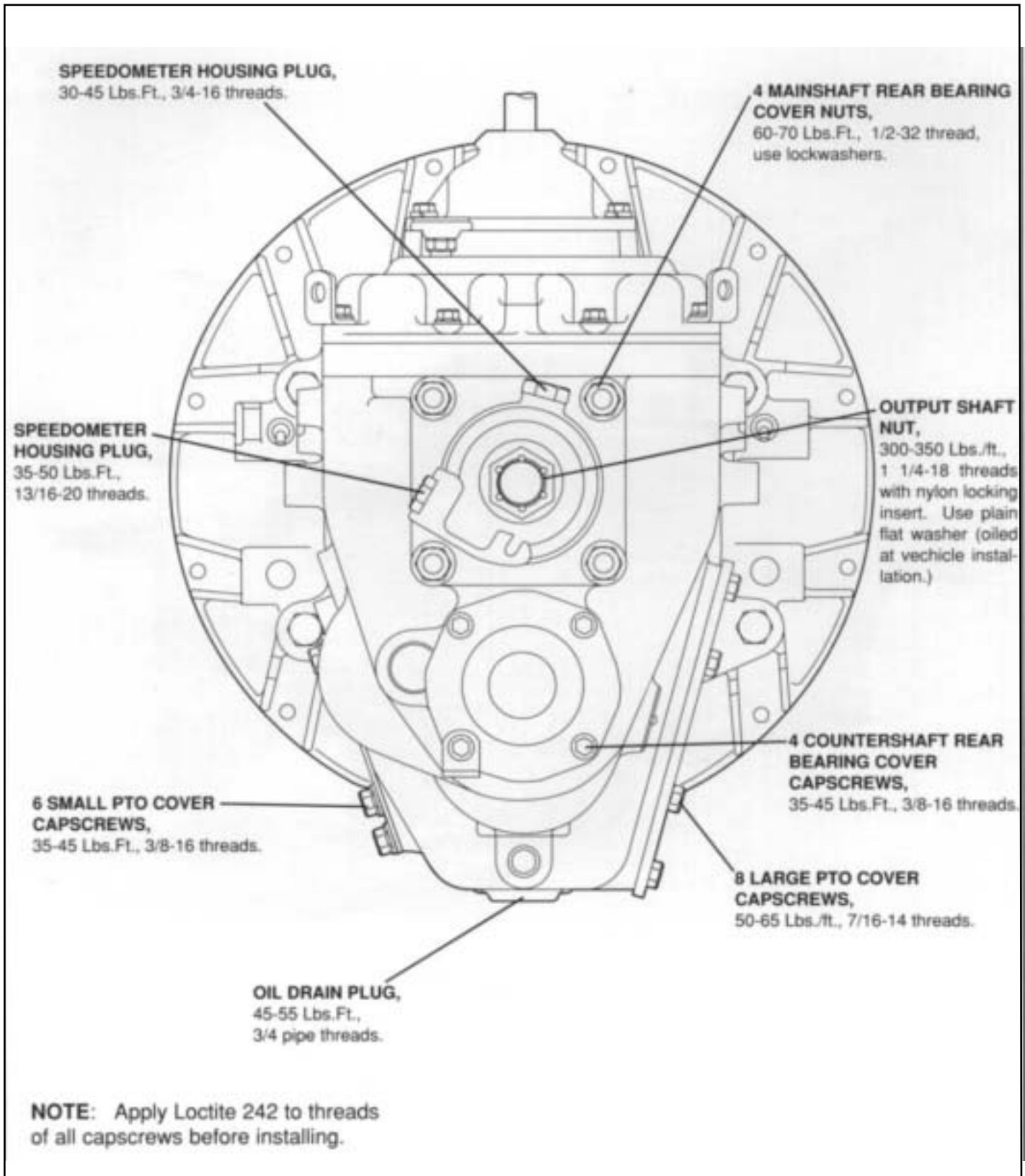

TORQUE RECOMMENDATIONS

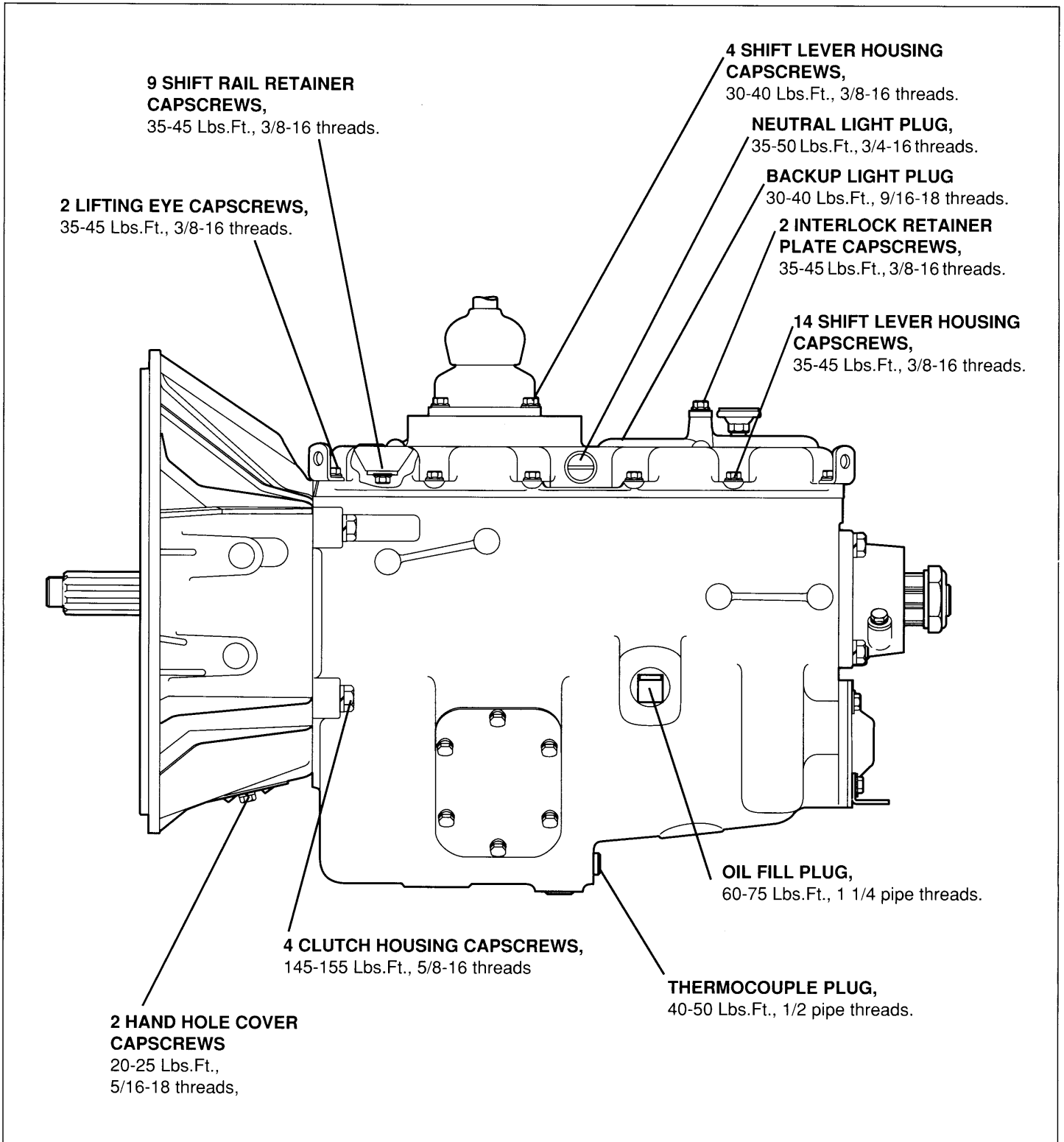

PREVENTIVE MAINTENANCE

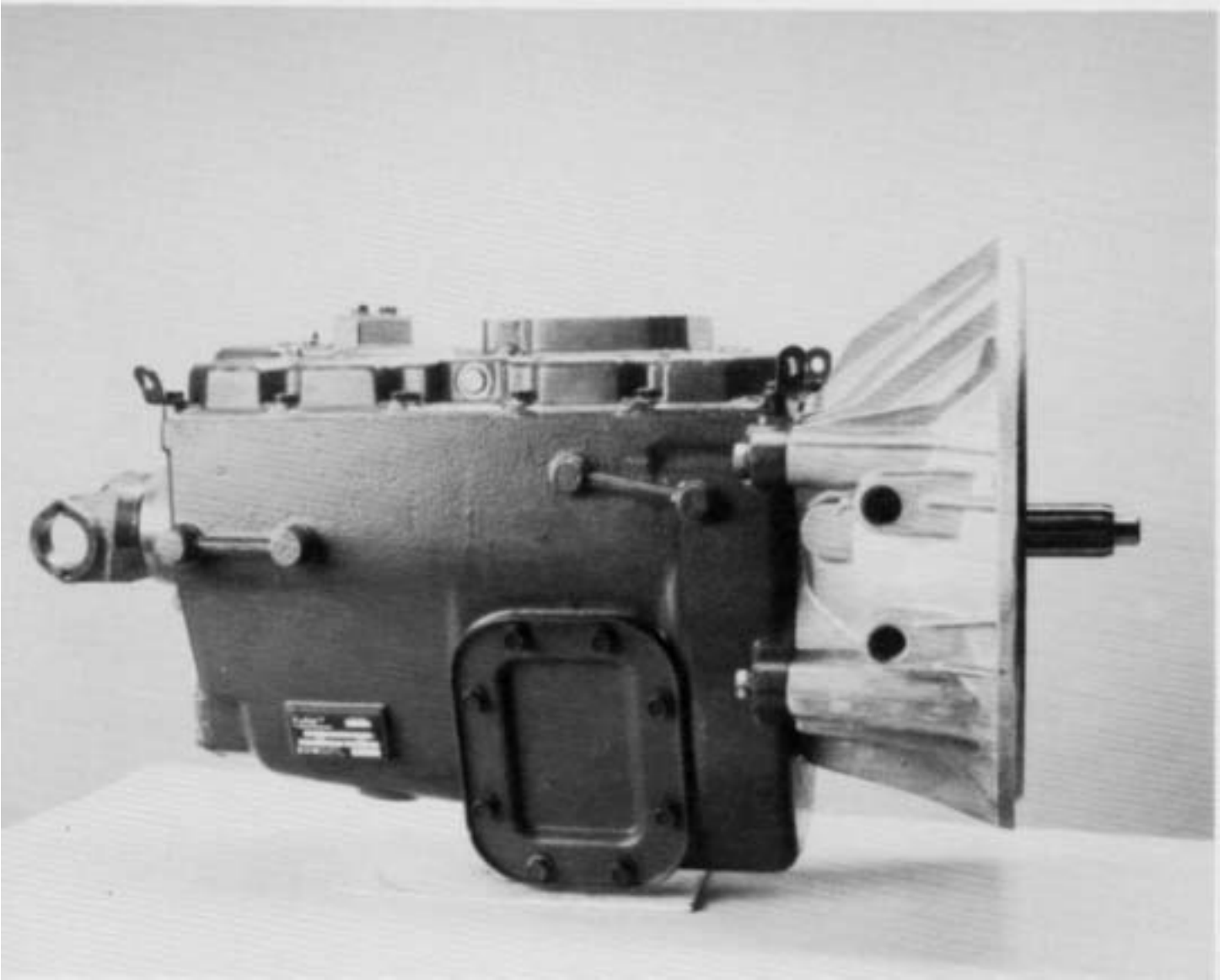

PREVENTIVE MAINTENANCE

PREVENTIVE MAINTENANCE CHECK CHART

CHECKS WITHOUT PARTIAL DISASSEMBLY OF CHASSIS OR CAB

1. **Clutch Housing Mounting**
 - a. Check all capscrews of clutch housing flange for looseness.
2. **Clutch Release Bearing (Not Shown)**
 - a. Remove hand hole cover and check radial and axial clearance in release bearing.
 - b. Check relative position of thrust surface of release bearing with thrust sleeve on push-type clutches.
3. **Clutch Pedal Shaft and Bores**
 - a. Pry upward on shafts to check wear.
 - b. If excessive movement is found, remove clutch release mechanism and check bushings in bores and wear on shafts.
4. **Lubricant**
 - a. Change at specified service intervals.
 - b. Use only the types and grades as recommended. See LUBRICATION.
5. **Filler and Drain Plugs**
 - a. Remove filler plug and check level of lubricant at specified intervals. Tighten filler and drain plugs securely.
6. **Capscrews, Retaining Nuts and Gaskets**
 - a. Check all capscrews, especially those on PTO covers, front and rear bearing covers for looseness which would cause oil leakage. See TORQUE RECOMMENDATIONS.
 - b. Check PTO opening and rear bearing covers for oil leakage.
 - c. Check the mainshaft rear bearing cover and countershaft rear bearing cover shims making sure a light coat of Loctite 510 was used on both sides of shims.
7. **Gear Shift Lever**
 - a. Check for looseness and free play in housing. If lever is loose in housing, proceed with Check No. 8.

8. Gear Shift Lever Housing Assembly

- a. Remove the gear shift lever housing assembly from transmission.
- b. Check tension spring and washer for set and wear.
- c. Check bottom end of gear shift lever for wear of slots. Also check for wear of shift finger assembly and shift blocks.

CHECKS WITH DRIVE LINE DROPPED

9. Universal Joint Companion Flange or Yoke Nut

- a. Check for tightness. Tighten to recommended torque.

10. Output Shaft (Not Shown)

- NOTE: Pry upward against output shaft to check radial clearance in mainshaft rear bearing.

CHECKS WITH UNIVERSAL JOINT COMPANION FLANGE OR YOKE REMOVED

NOTE: If necessary, use a clean shop rag to clean sealing surface of companion flange or yoke. DO NOT USE CROCUS CLOTH, EMERY PAPER OR OTHER ABRASIVE MATERIALS THAT WILL MAR THE REAR SEAL SEALING SURFACE FINISH.

11. Splines on Output Shaft (Not Shown)

- a. Check for wear from movement and chucking action of the universal joint companion flange or yoke.

12. Mainshaft Rear Bearing Cover

- a. Check oil seal for wear.

PRECAUTIONS

Disassembly

It is assumed in the detailed assembly instructions that the lubricant has been drained from transmission, the necessary linkage disconnected and the transmission has been removed from vehicle chassis. Removal of the gear shift lever housing assembly is included in the detailed instructions (Disassembly and Reassembly-Shift-ing Controls); however, this assembly must be detached from shift bar housing before transmission can be re-moved.

FOLLOW CLOSELY EACH PROCEDURE IN THE DETAILED INSTRUCTIONS, MAKING USE OF THE TEXT, ILLUSTRATIONS AND PHOTOGRAPHS PROVIDED.

- 1. BEARINGS** - Carefully wash and relubricate all reusable bearings as removed and protectively wrap until ready for use. Remove bearings planned to be reused with pullers designed for this purpose.
- 2. ASSEMBLIES** - When disassembling the various assemblies, such as the mainshaft, countershaft, and shift bar housing, lay all parts on a clean bench in the same sequence as removed. This procedure will simplify reassembly and reduce the possibility of losing parts.
- 3. SNAP RINGS** - Remove snap rings with pliers designed for this purpose. Snap rings removed in this manner can be reused, if they are not sprung or loose.
- 4. CLEANLINESS** - Provide a clean place to work. It is important that no dirt or foreign material enters the unit during repairs. Dirt is an abrasive and can damage bearings. It is always good practice to clean the outside of the unit before starting the planned disassembly.
- 5. WHEN USING TOOLS TO MOVE PARTS** - Always apply force to shafts, housings, etc, with restraint. Movement of some parts is restricted. Never apply force to the part being driven after it stops solidly. The use of soft hammers, bars and mauls for all disassembly work is recommended.

Inspection

Before reassembling the transmission, check each part carefully for abnormal or excessive wear and damage to determine reuse or replacement. When replacement is necessary, use only genuine Eaton Fuller Transm[s-]ion parts to assure continued performance and extended life from your unit.

Since the cost of a new part is generally a small fraction of the total cost of downtime and labor, avoid reusing a questionable part which could lead to additional repairs and expense soon after initial reassembly. To aid in determining the reuse or replacement of any transmission part, consideration should also be given to the unit's history, mileage, application, etc.

Recommended inspection procedures are provided in the following checklist.

A. BEARINGS

1. Wash all bearings in clean solvent. Check balls, rollers and raceways for pitting, discoloration, and spalled areas. Replace bearings that are pitted, discolored, spalled, or damaged during disassembly.
2. Lubricate bearings that are not pitted, discolored, or spalled and check for axial and radial clearances.
Replace bearings with excessive clearances.
3. Check bearing fits. Bearing inner races should be tight to shaft; outer races slightly tight to slightly loose in case bore. If bearing spins freely in bore, however, case should be replaced.

B. GEARS

1. Check gear teeth for frosting and pitting. Frosting of gear tooth faces present no threat of transmission failure. Often in continued operation of the unit, frosted gears will "heal" and not progress to the pitting stage. In most cases, gears with light to moderate pitted teeth have considerable gear life remaining and can be reused, but gears with advanced stage pitting should be replaced.
2. Check for gears with clutching teeth abnormally worn, tapered, or reduced in length from clashing in shifting. Replace gears found in any of these conditions.

PRECAUTIONS

Inspection (cont'd.)

3. Check axial clearance of gears. Where excessive clearance is found, check gear snap ring, split washer, clutch hub, and gear hub for excessive wear.

C. SPLINES

1. Check splines on all shafts for abnormal wear. If sliding clutch gears, companion flange, or clutch hub have worn into the sides of the splines, replace the specific parts affected.

D. SPLIT WASHERS

1. Check surfaces of all washers. Washers scored or reduced in thickness should be replaced.

E. REVERSE IDLER GEAR ASSEMBLIES

1. Check for excessive wear from action of roller bearings.

F. GRAY IRON PARTS

1. Check all gray iron parts for cracks and breaks. Replace or repair parts found to be damaged. Heavy castings may be welded or brazed provided the cracks do not extend into bearing bores or bolting surfaces. When welding, however, never place the ground so as to allow current to pass through the transmission.

G. CLUTCH RELEASE PARTS

1. Check clutch release parts. Replace yokes worn at cam surfaces and bearing carrier worn at contact pads.
2. Check pedal shafts. Replace those worn at bushing surfaces.

H. SHIFT BAR HOUSING ASSEMBLY

1. Check for wear on shift yokes, shift blocks and finger assembly at pads and lever slot. Replace excessively worn parts.
2. Check yokes for correct alignment. Replace sprung yokes.
3. Check lockscrews in yoke assembly retainer plates. Tighten those found loose.
4. Check roll pins retaining shift yokes and shift blocks for tightness. Replace broken, loose or worn roll pins.

I. GEAR SHIFT LEVER HOUSING ASSEMBLY

1. Check spring tension on shift lever. Replace tension spring if lever moves too freely.
2. If housing is disassembled, check bottom end of gear shift lever and shift finger assembly for wear. Replace both parts if excessively worn.

J. BEARING COVERS

1. Check covers for wear from thrust of adjacent bearing. Replace covers damaged from thrust of bearing outer race.
2. Check bores of covers for wear. Replace those worn oversize.

K. OIL SEALS

1. Check oil seal in input shaft and rear bearing cover. If sealing action of lip has been destroyed, replace seal.

L. CLUTCHING TEETH

1. Check all shift yokes and shift hub of sliding clutches for extreme wear or discoloration from heat.
2. Check engaging teeth of mainshaft gears for partial engagement pattern or excessive wear.

M. SYNCHRONIZER ASSEMBLY

1. Check synchronizer for burrs, uneven and excessive wear at contact surface, and metal particles.
2. Check blocker pins for excessive wear or looseness.
3. Check synchronizer contact surfaces on the synchronizer cups for wear.

N. COUNTERSHAFT FRONT BORE PLUG

1. Check for damage or misalignment during installation.
2. The bore plug's outer diameter must be coated with Loctite gasket sealant 71217.

O. O-RINGS

1. Inspect the countershaft rear bearing housing for damaged O-rings.
2. Inspect the reverse idler shaft O-ring for wear or damage.

PRECAUTIONS

Reassembly

Make sure that interiors of case and housings are clean. It is important that dirt and other foreign materials be kept out of the transmission during reassembly. Dirt is an abrasive and can damage polished surfaces of bearings and washers. Use certain precautions, as listed below, during reassembly.

1. **GASKETS** - Use new gaskets throughout the transmission as it is being rebuilt. Make sure all gaskets are installed. An omission of any gasket can result in oil leakage or misalignment of bearing covers. Install PTO and shift bar housing gaskets dry.
2. **CAPSCREWS** - TO prevent oil leakage and loosening, use Loctite 262, Fuller part number 71225, thread sealant on all capscrews. For torque ratings, see TORQUE RECOMMENDATIONS.
3. **SHIMS** - Apply a light coat of Loctite 510, Fuller part number 71217, to both sides of shims before final installation to prevent leakage.
4. **ASSEMBLY** - Refer to the illustrations provided in the detailed disassembly instructions as a guide to reassembly.
5. **INITIAL LUBRICATION** - Coat all split washers, thrust washers, synchronizers, bearing surfaces on gears, bushings, gear working surfaces, shift fork pads, and bearings with transmission lubricant during reassembly to prevent damage during initial start up.
6. **END PLAY** - Maintain .006 -.010 end play on countershaft and mainshaft assemblies.
7. **BEARINGS** - Use of a sleeve type driver that contacts the inner race of the bearing is recommended to prevent damage to the rollers and cage.
8. **UNIVERSAL JOINT COMPANION FLANGE OR YOKE** - Pull the companion flange or yoke into place with the output shaft nut, using 300-350 foot-pounds (407-475 Nm) of torque. Make sure the speedometer drive gear or a replacement spacer has been installed. Failure to properly torque the nut can result in damage to the mainshaft rear bearing.
9. **OIL SEALS** - Outer diameters of steel oil seals must have gasket sealant 71217 applied before installation. Oil seals must have grease 71215 applied to the sealing surface before installation.
10. **COUNTERSHAFT FRONT BORE PLUG** - The outer diameter of the bore plug must be coated with gasket sealant 71217 before installation.
11. **CAPSCREWS, FASTENERS AND NUTS** - Reused capscrews, fasteners and nuts must have thread sealant adhesive 71225 applied to threads before installation.

IMPORTANT: REFER TO THE APPROPRIATE ILLUSTRATED PARTS LIST (SPECIFIED BY MODEL SERIES) TO ENSURE THAT PROPER PARTS ARE USED DURING REASSEMBLY OF THE TRANSMISSION.

DISASSEMBLY AND REASSEMBLY SHIFTING CONTROLS

GEARSHIFT LEVER HOUSING ASSEMBLY

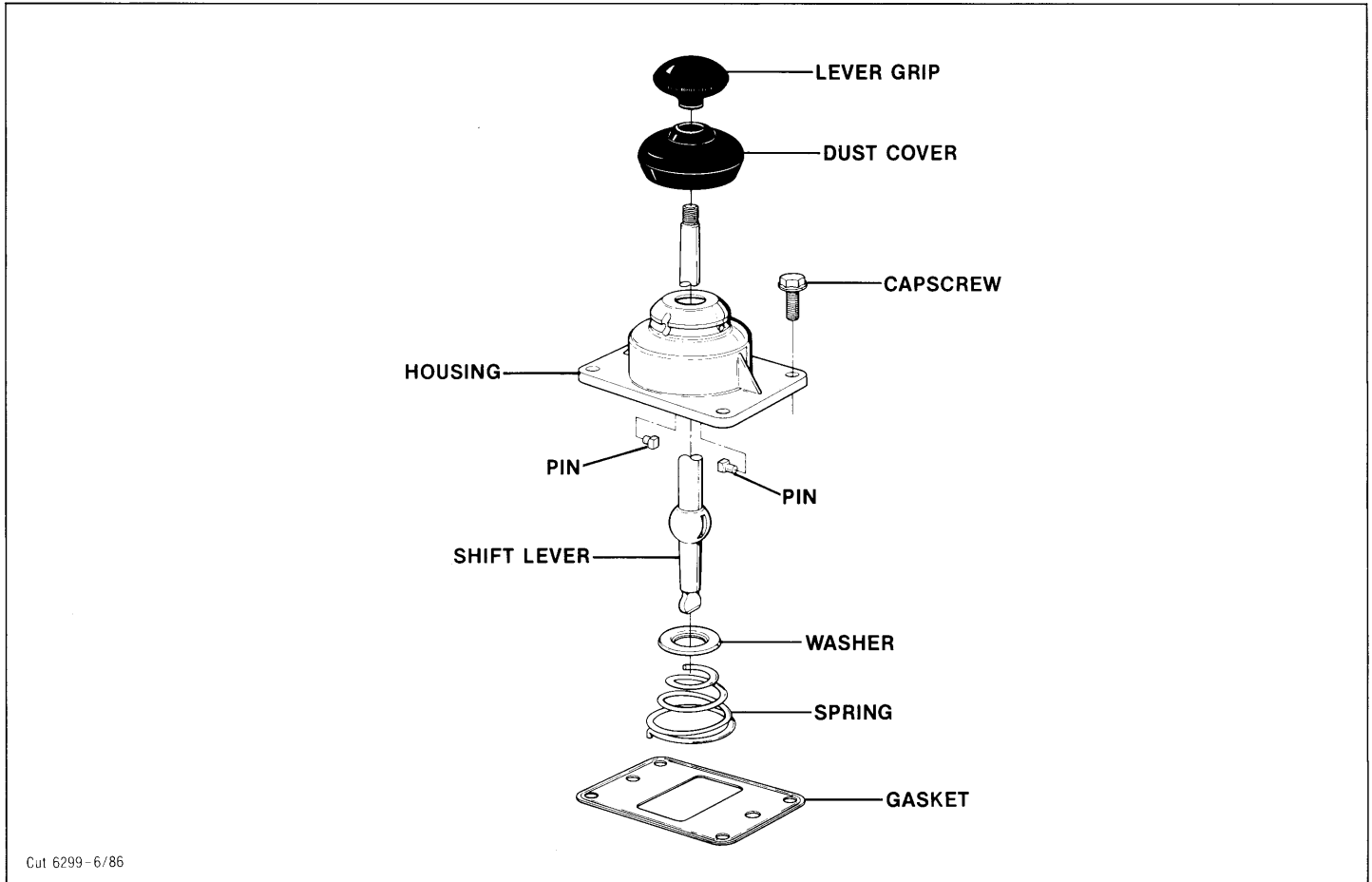

A. Removal and Disassembly

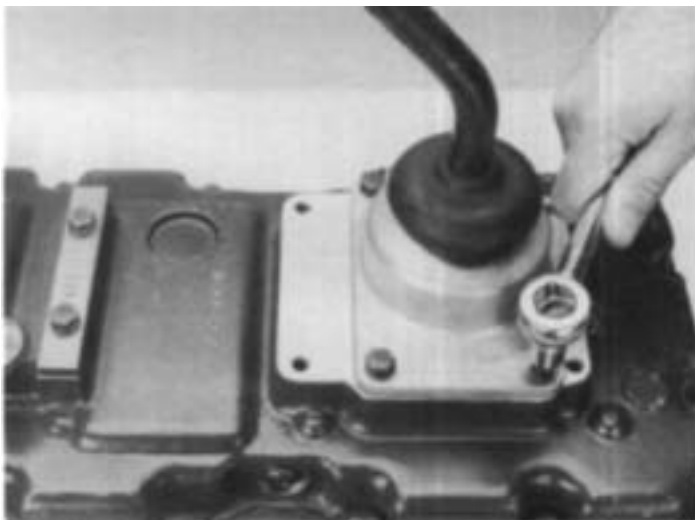

1. Turn out four capscrews and remove lower assembly and gasket from shift bar housing.

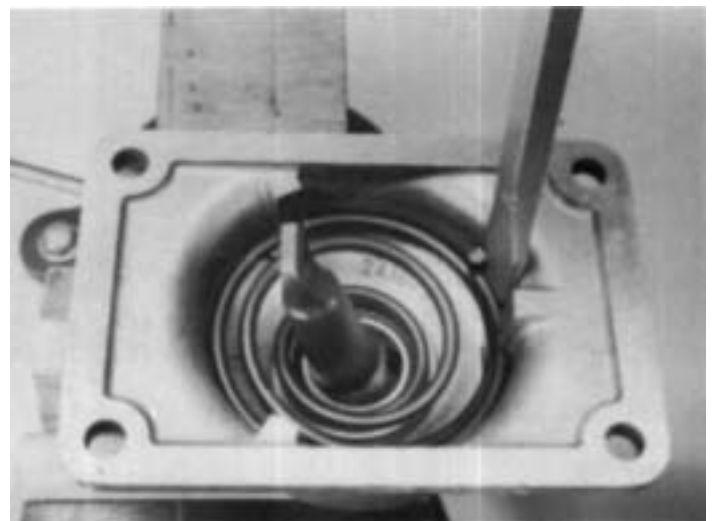

2. Remove shift lever grip and boot from shift lever, secure assembly in vise with bottom of housing up. Use a large screwdriver to twist between spring and housing, forcing spring from under lugs in housing. Do one coil at a time.

DISASSEMBLY AND REASSEMBLY SHIFTING CONTROLS

GEARSHIFT LEVER HOUSING ASSEMBLY (con't.)

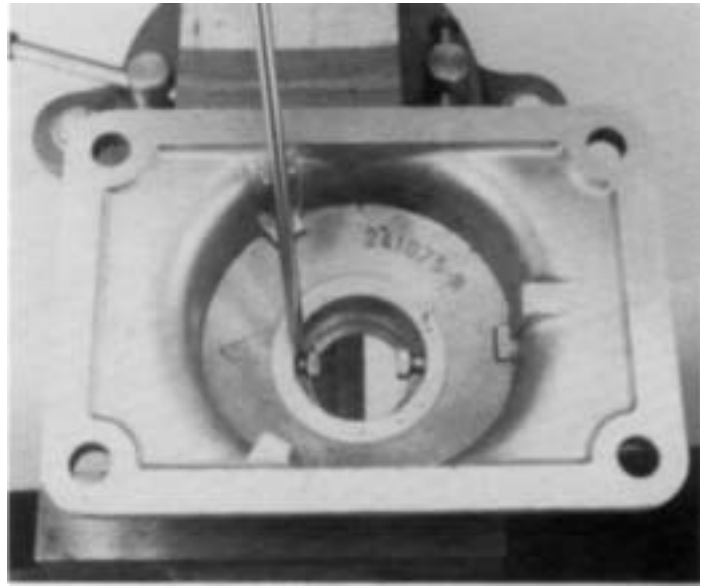

3. Remove tension spring, washer and gearshift lever from housing.

4. Remove spade pins from bore in housing.

B. Reassembly of Gearshift Lever Housing Assembly

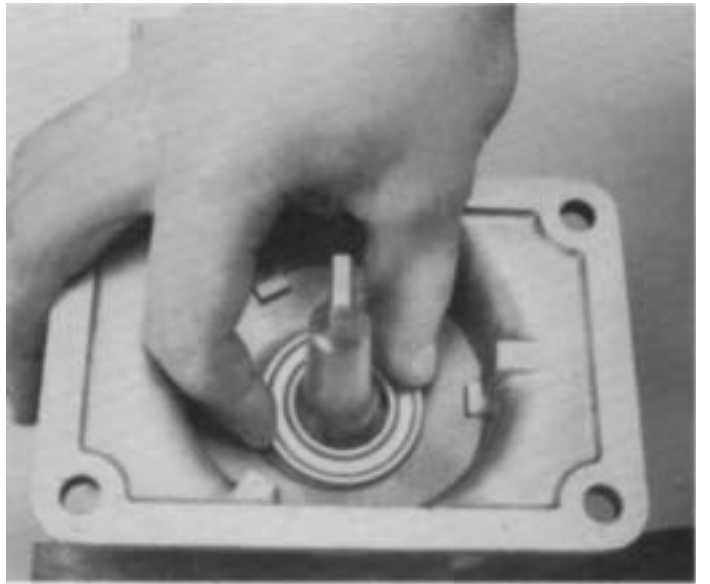
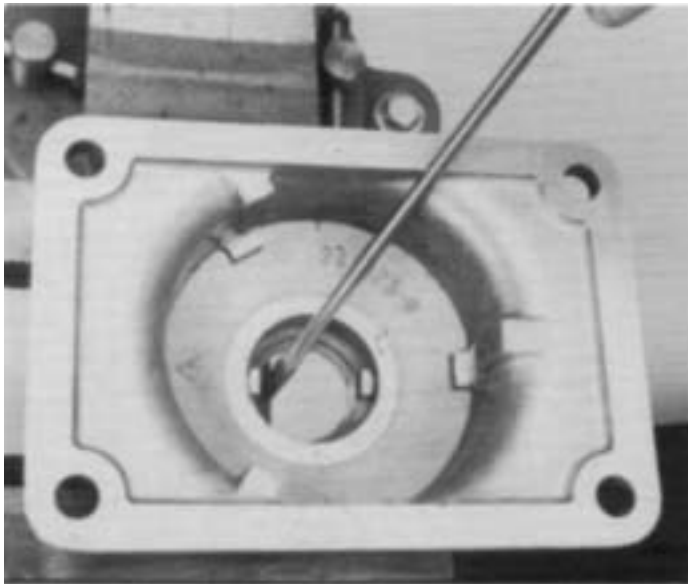

1. With gearshift lever housing secured in vise as during disassembly, install spade pins in bore of housing.

2. Position gearshift lever in housing with spade pins in lever ball slot and install tension spring washer over ball, dished side up.

DISASSEMBLY AND REASSEMBLY SHIFTING CONTROLS

GEARSHIFT LEVER HOUSING ASSEMBLY (con't.)

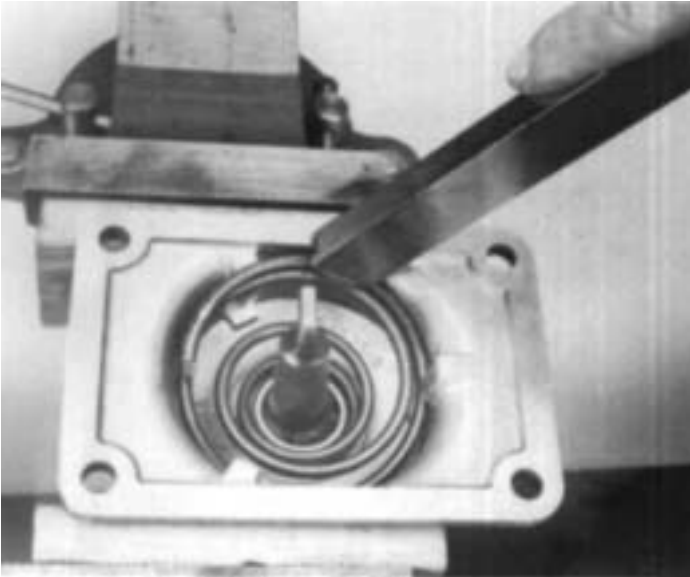

3. Install tension spring under lugs in housing, seating one coil at a time. Use of a spring driving tool is recommended.

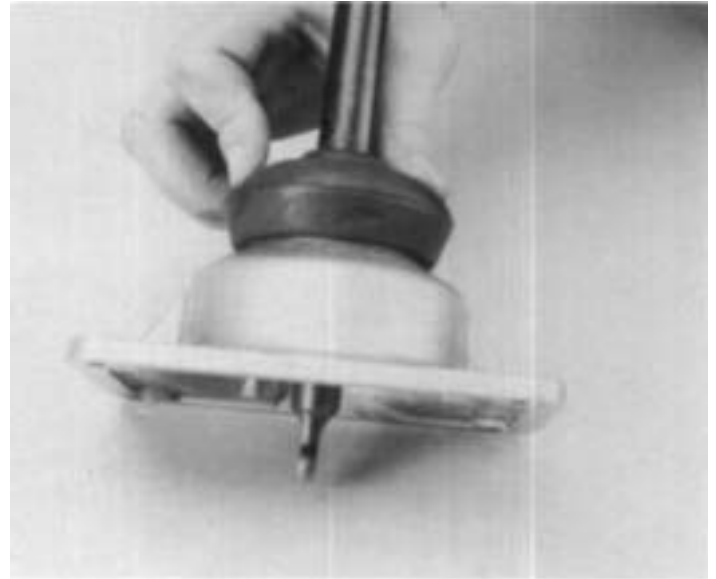

4. Remove assembly from vise and install rubber boot over gearshift lever and against housing. install shift lever grip.

DISASSEMBLY AND REASSEMBLY SHIFTING CONTROLS

SHIFT BAR HOUSING ASSEMBLY

A. Removal and Disassembly Round Rail Design

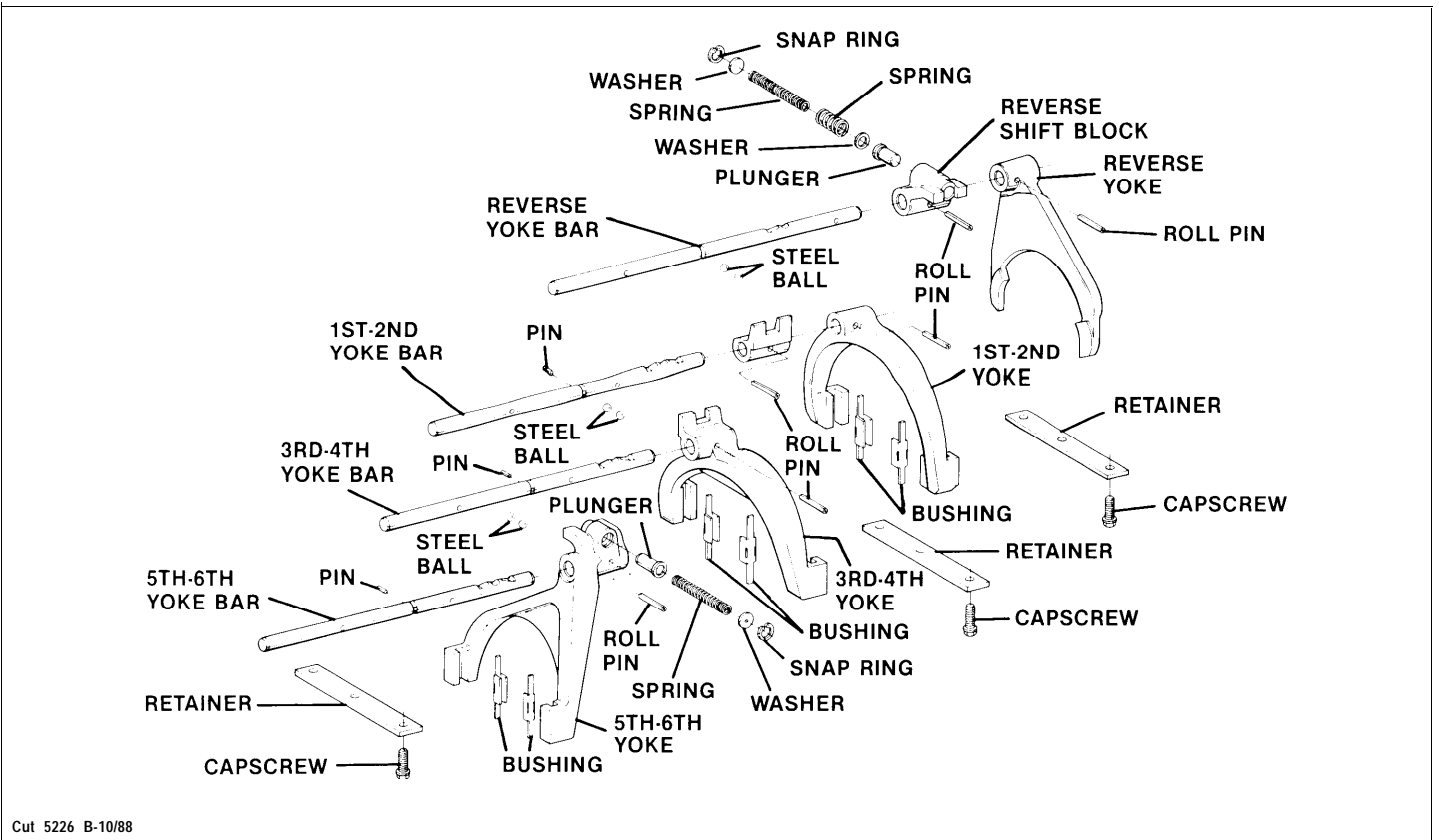
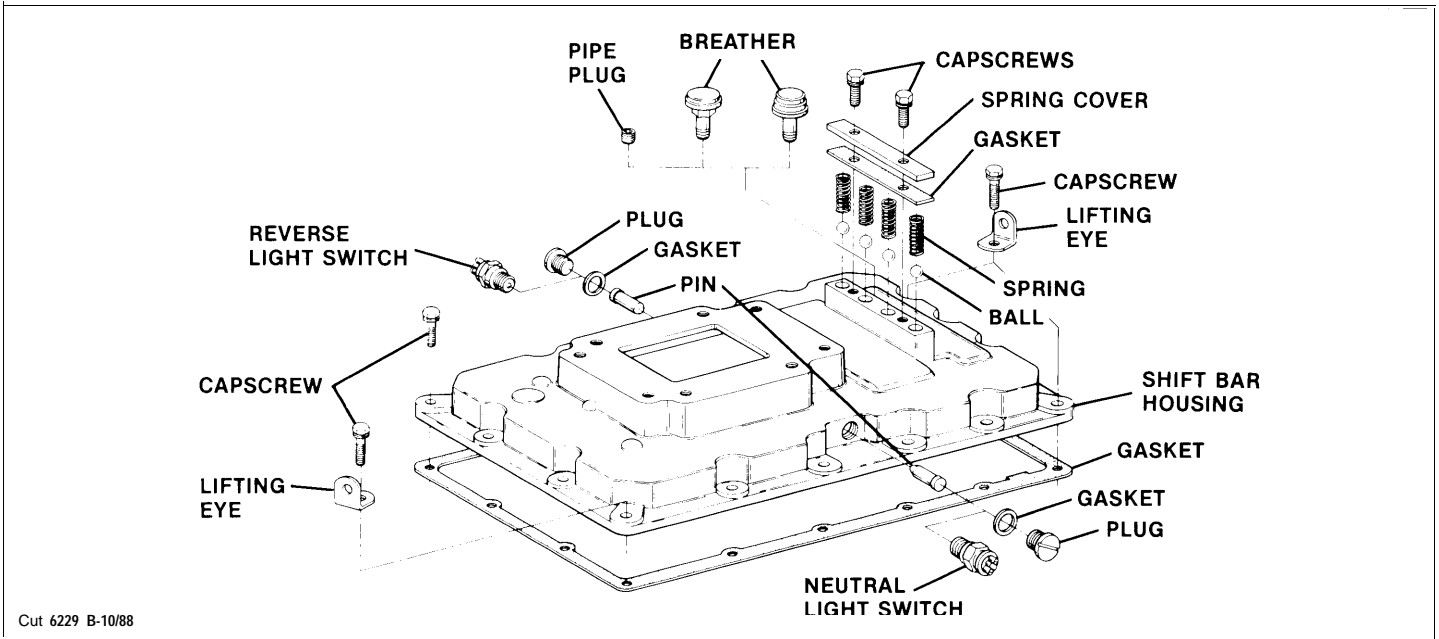

DISASSEMBLY AND REASSEMBLY SHIFTING CONTROLS

SHIFT BAR HOUSING ASSEMBLY (con't.)

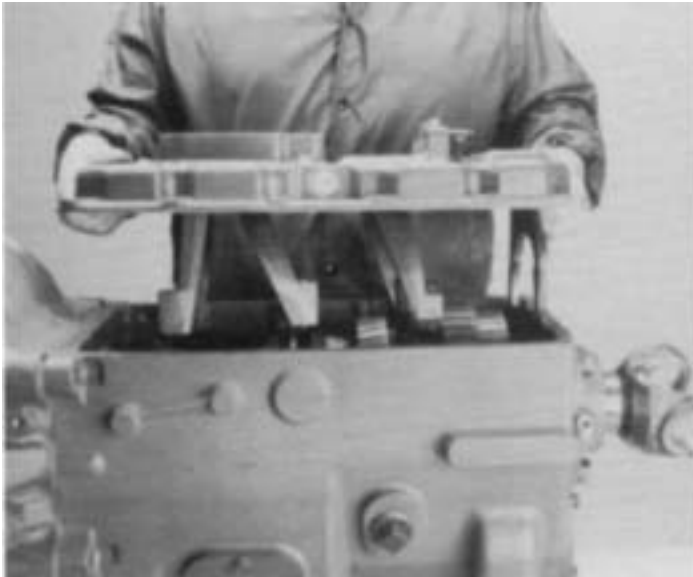

1. Turn out capscrews and lift shift bar housing from case.

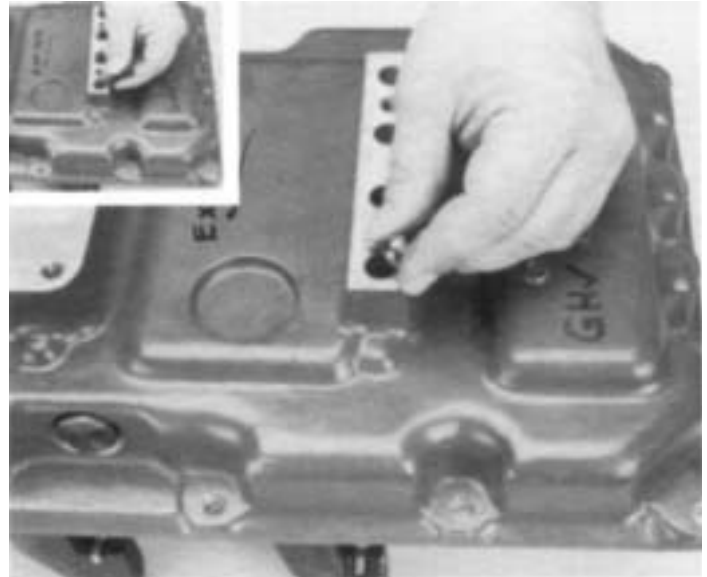

3. Tilt the assembly and remove the four sets of tension springs (inset) and balls from bores in top of shift bar housing.

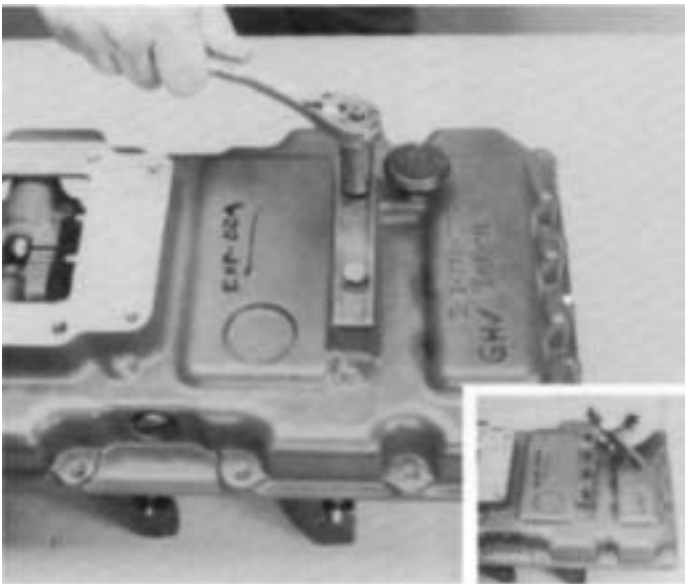

2. Remove the two tension plate capscrews, and the spring cover and gasket (inset).

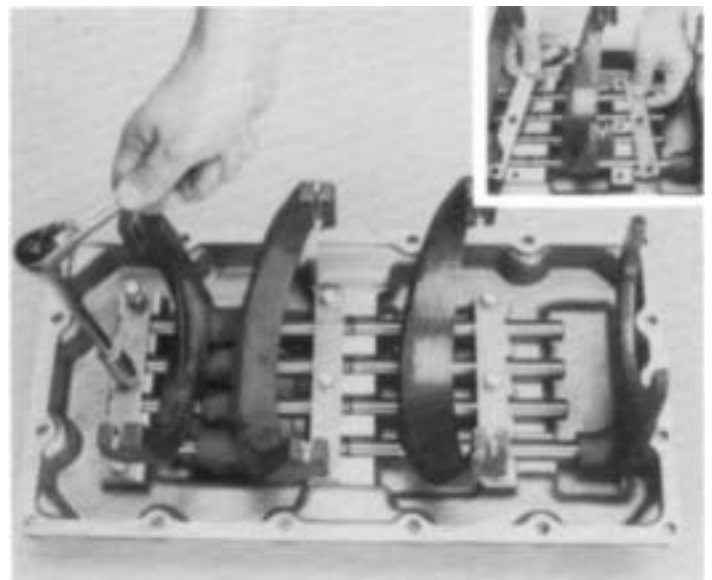

4. Lay shift bar housing on work bench as shown, remove nine capscrews and three retaining plates (inset).

DISASSEMBLY AND REASSEMBLY SHIFTING CONTROLS

SHIFT BAR HOUSING ASSEMBLY (con'd.)

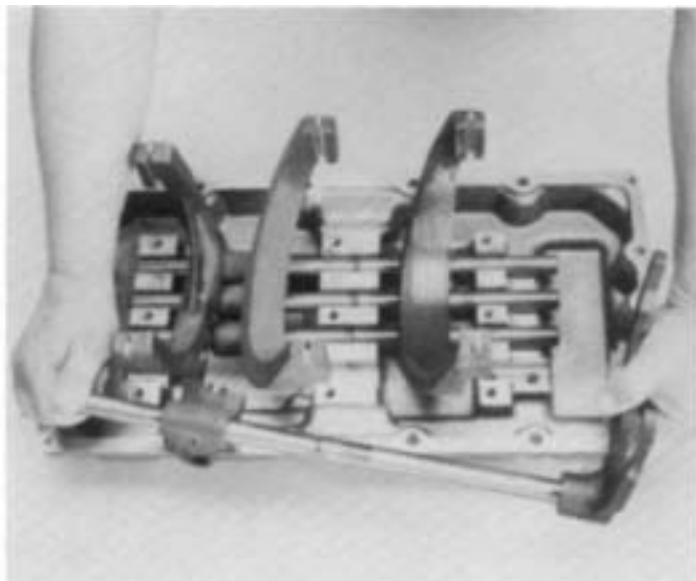

5. Remove the reverse yoke assembly from the shift bar housing.

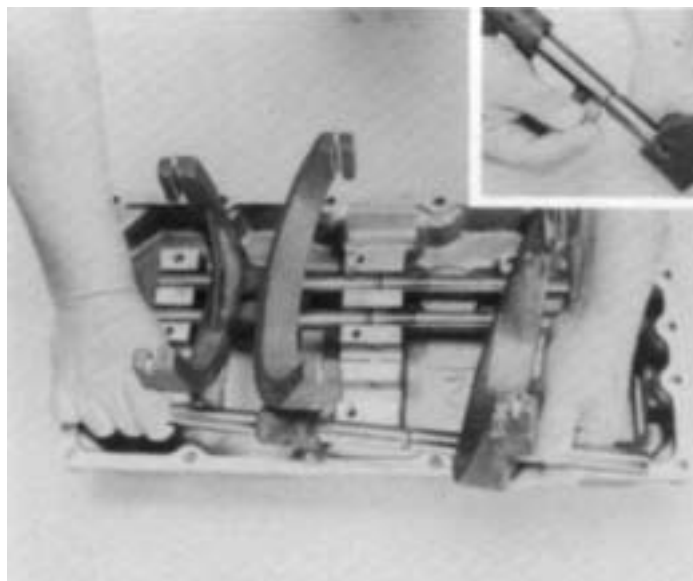

7. Remove the 3rd-4th yoke assembly, and interlock pin (inset).

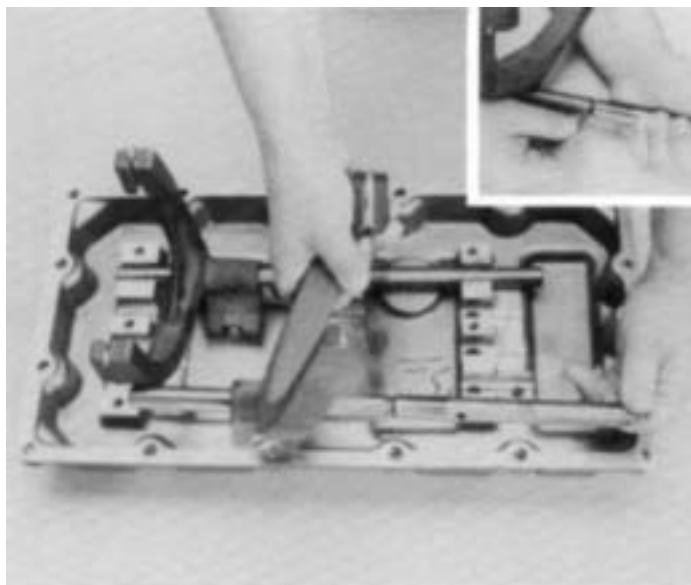

6. Remove the 1st-2nd yoke assembly from the shift bar housing and remove the 1st-2nd interlock pin (inset), as shown.

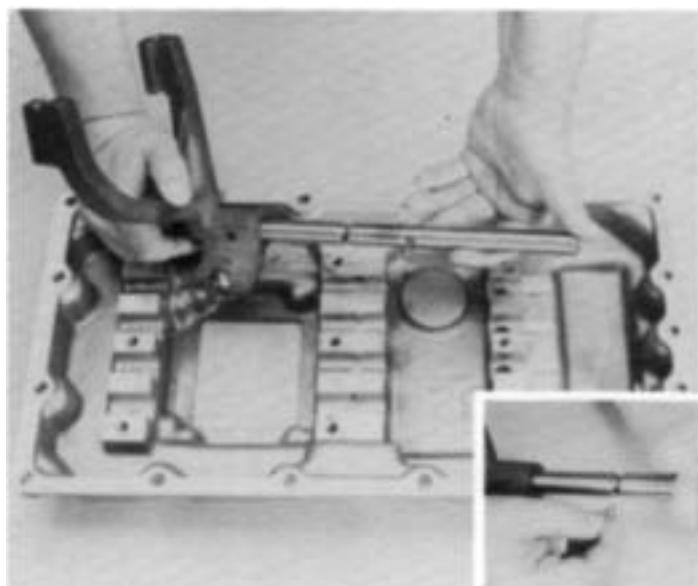

8. Remove the 5th-6th yoke assembly, and interlock pin (inset).

DISASSEMBLY AND REASSEMBLY SHIFTING CONTROLS

SHIFT BAR HOUSING ASSEMBLY (con'd.)

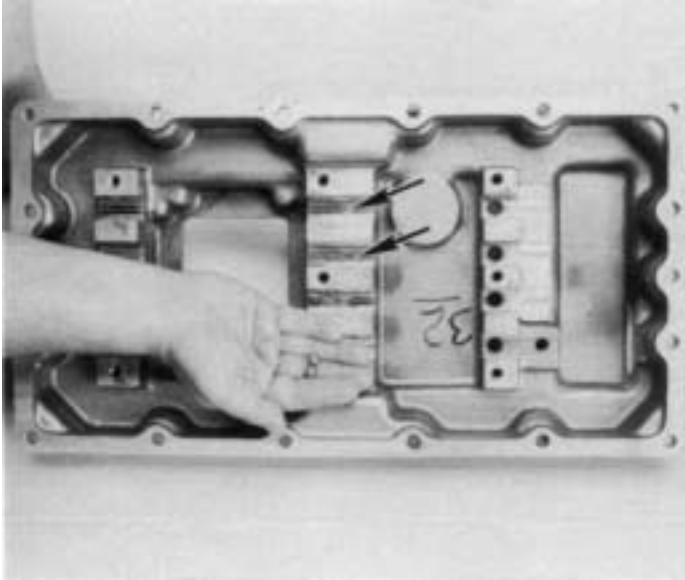

9. Remove the six interlock balls from the shift bores of the shift bar housing.

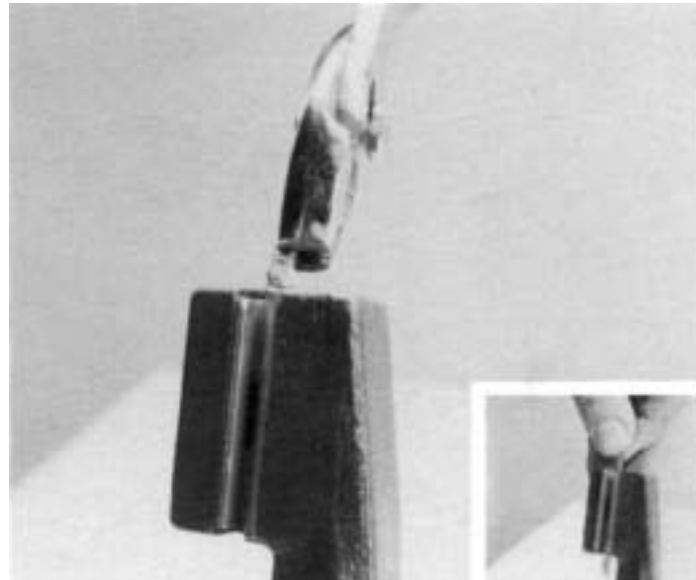

11. If necessary the shift yoke bushings can be removed. Use pliers to bend the bushing tabs straight then pull the bushings from the yoke slot (inset).

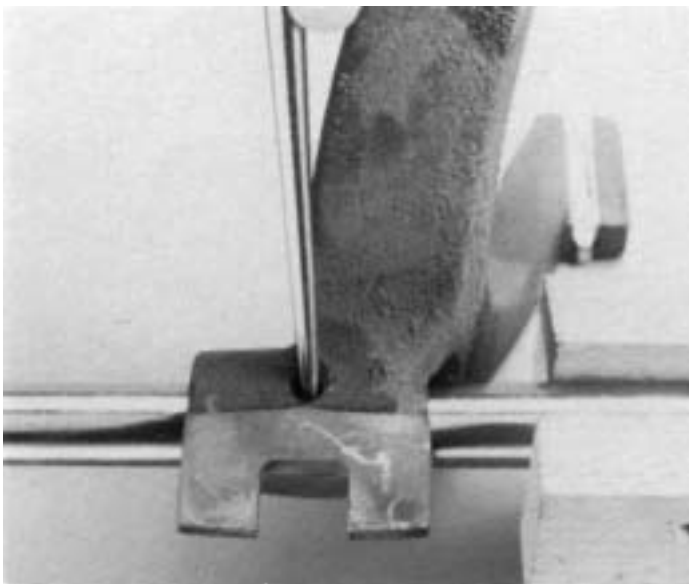

10. If it is necessary to replace yoke or shift blocks, secure shift rail in a vice equipped with brass jaws or wood blocks. Drive the retension/roll pin from yoke and yoke bar as shown.

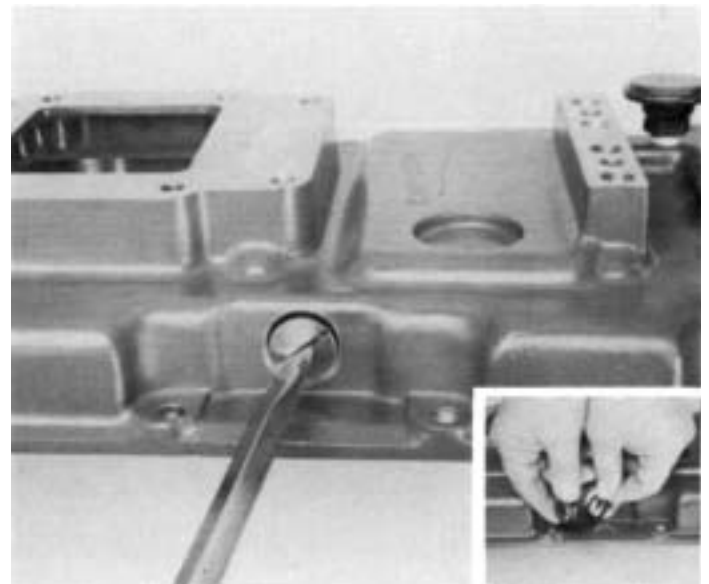

12. Loosen the neutral light switch/or plug. Remove the neutral light switch or plug and gasket from the housing (inset).

DISASSEMBLY AND REASSEMBLY SHIFTING CONTROLS

SHIFT BAR HOUSING ASSEMBLY (con't.)

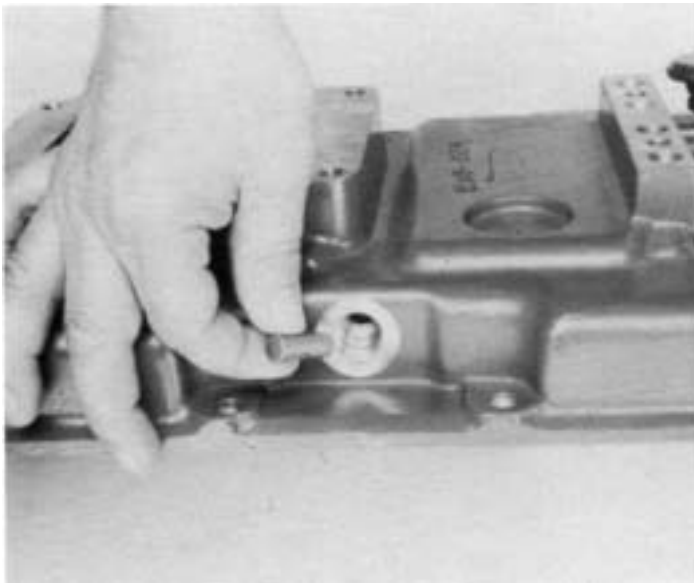

13. Remove the pin from the neutral light switch bore. Note: The neutral light switch pin and the reverse light switch pin are not interchangeable.



15. Remove the pin from the reverse light switch bore.

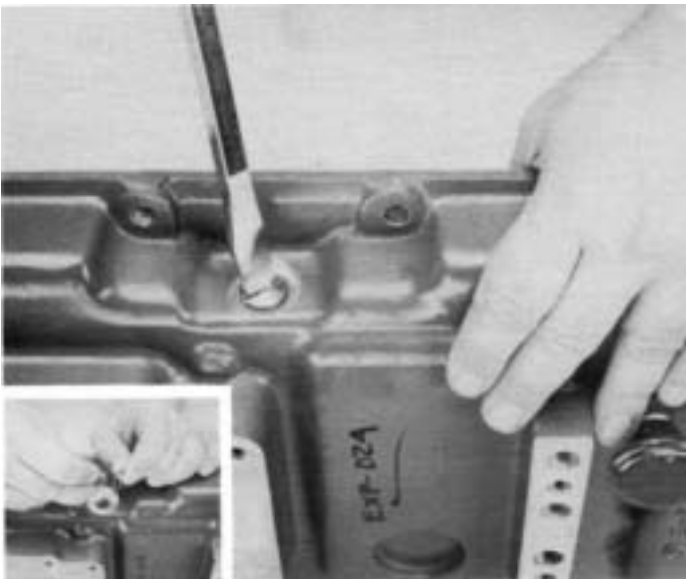

14. Loosen the reverse light switch/or plug. Remove the light switch/or plug and gasket from the housing (inset).



16. If the removal of reverse plunger is necessary, secure the shift rail and yoke in an Arbor press.

CAUTION

THE SNAP RING AND RETAINER PLATE ARE UNDER SPRING TENSION.

Depress the reverse plunger spring and remove the snap ring.

DISASSEMBLY AND REASSEMBLY SHIFTING CONTROLS

SHIFT BAR HOUSING ASSEMBLY (con't.)

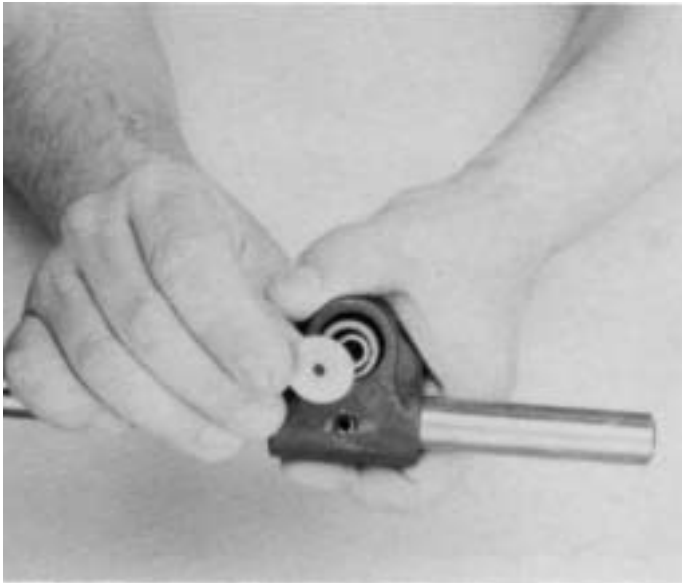

17. Remove the retaining plate.



19. Remove the reverse plunger washer.

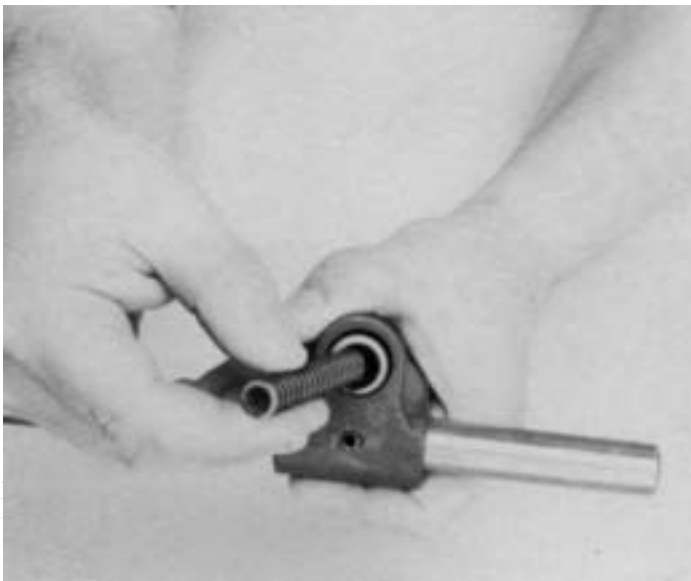

18. Remove the inner reverse plunger spring, then remove the outer plunger spring (inset). **Note:** The reverse and neutral plunger springs are not interchangeable. Keep them separated.

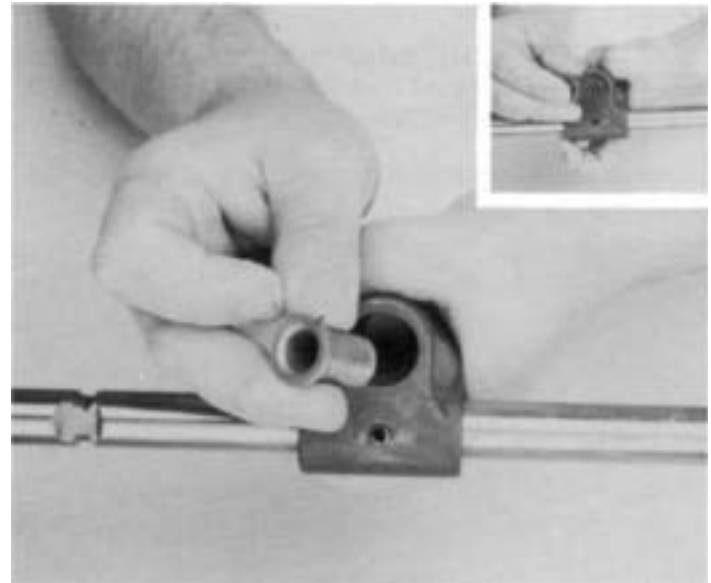

20. Remove the reverse plunger.

DISASSEMBLY AND REASSEMBLY SHIFTING CONTROLS

SHIFT BAR HOUSING ASSEMBLY (con't.)



21. If the removal of neutral plunger is necessary, secure the 5th-6th shift yoke assembly in an Arbor press.

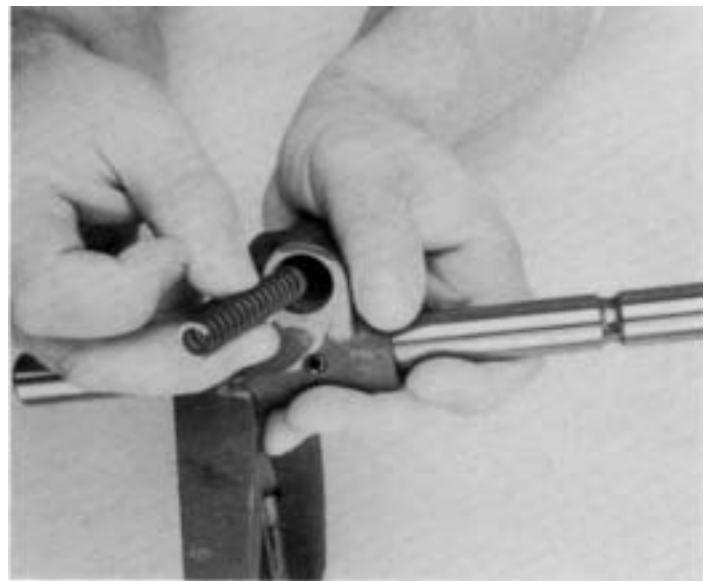

23. Remove the neutral plunger spring. Note: The neutral and reverse plunger springs are not interchangeable. Keep them separate.



THE SNAP RING AND RETAINER PLATE ARE UNDER SPRING TENSION.

Depress the neutral plunger spring and remove snap ring.

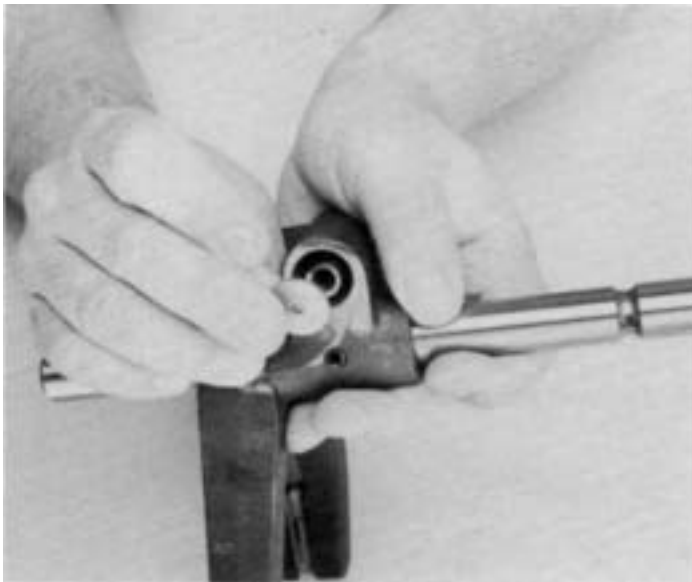

22. Remove the retaining plate.

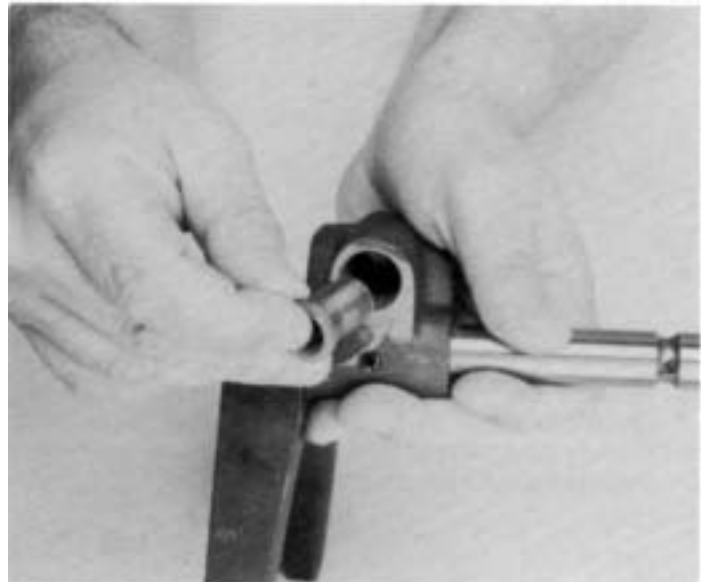

24. Remove the neutral plunger.

DISASSEMBLY AND REASSEMBLY SHIFTING CONTROLS

SHIFT BAR HOUSING ASSEMBLY (con't.)

B. Reassembly Round Rail Shift Bar Housing.

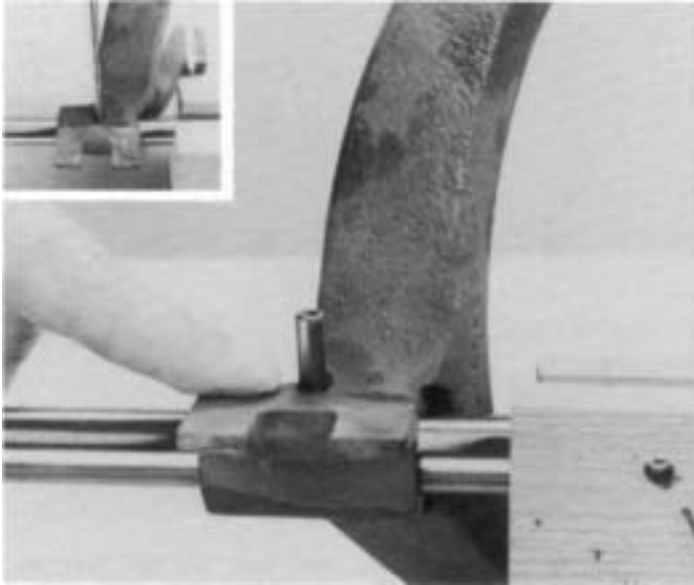

1. If previously removed install yoke or shift block on yoke bar. Secure assembly in a vise with soft jaws or wood blocks. Align holes in shift yoke or shift block and insert lock pin. Drive lock pin flush with shift yoke (inset).

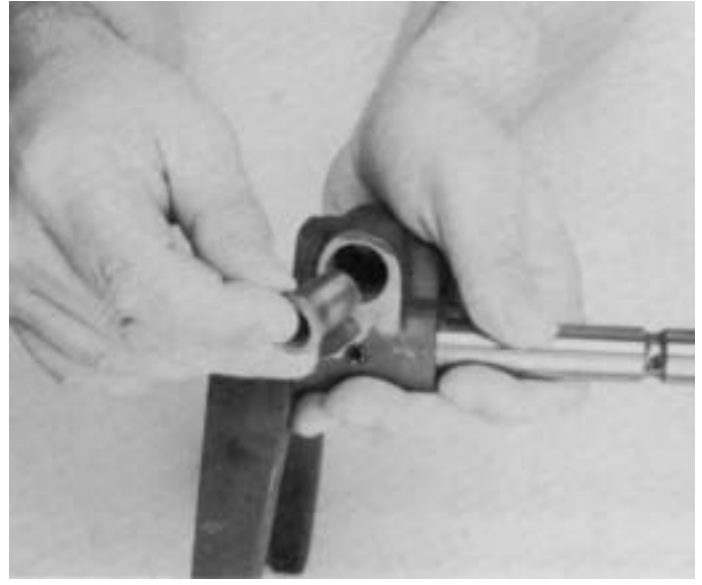

3. If neutral plunger was removed, install neutral plunger in 5th-6th shift yoke.

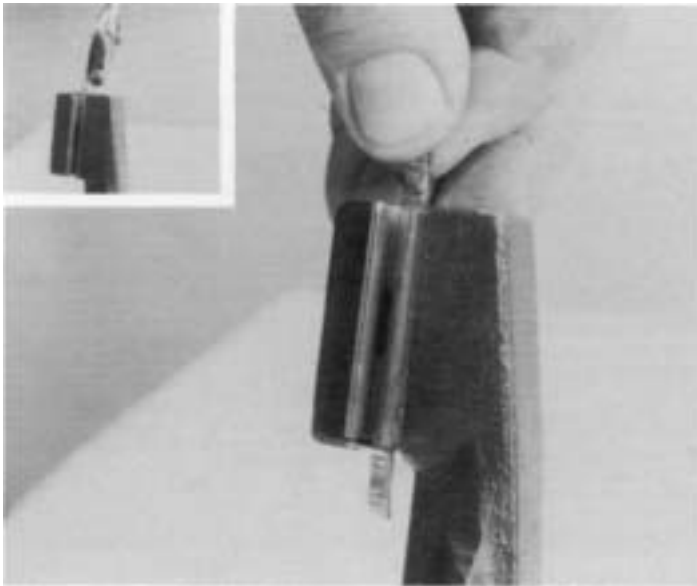

2. If previously removed install new shift yoke bushings in slot of 1st-2nd, 3rd-4th or 5th-6th shift yoke. Seat bushing in slot and bend bushing tabs over to secure (inset).

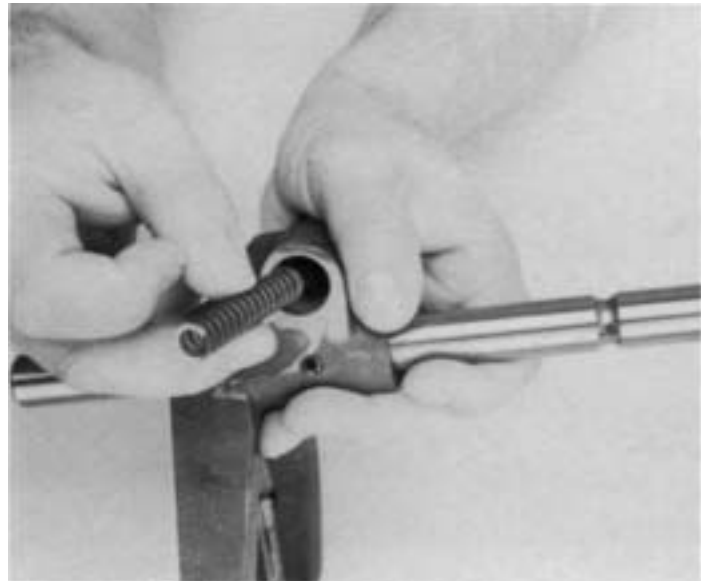

4. Install neutral plunger spring in shift yoke.

DISASSEMBLY AND REASSEMBLY SHIFTING CONTROLS

SHIFT BAR HOUSING ASSEMBLY (con't.)



5. Install neutral retaining washer.



THE SNAP RING AND RETAINER
WILL BE UNDER SPRING TENSION
AS INSTALLED.

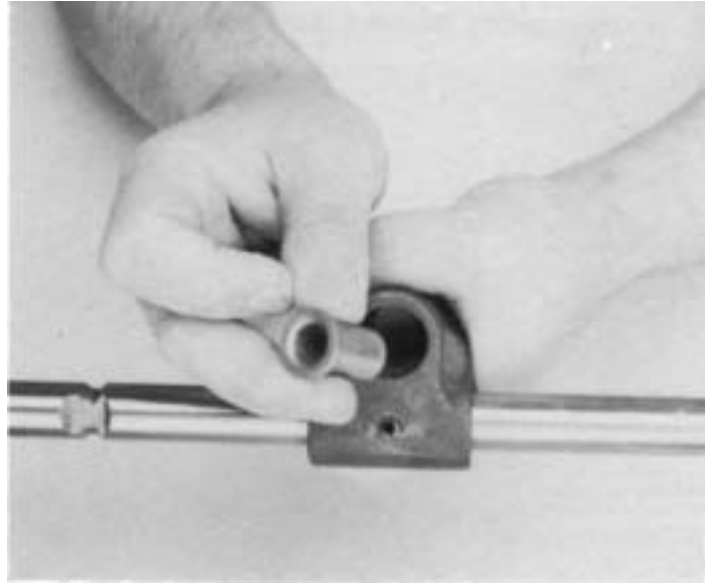

7. If reverse plunger was removed, install reverse plunger in reverse shift yoke.



6. Place shift yoke in hand press. Depress retaining washer and spring and install the snap ring.

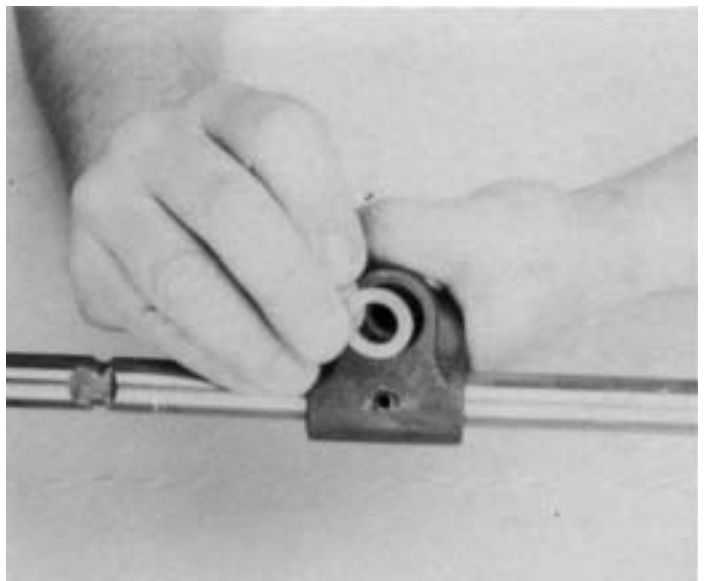

8. Install reverse plunger washer.

DISASSEMBLY AND REASSEMBLY SHIFTING CONTROLS

SHIFT BAR HOUSING ASSEMBLY (con't.)

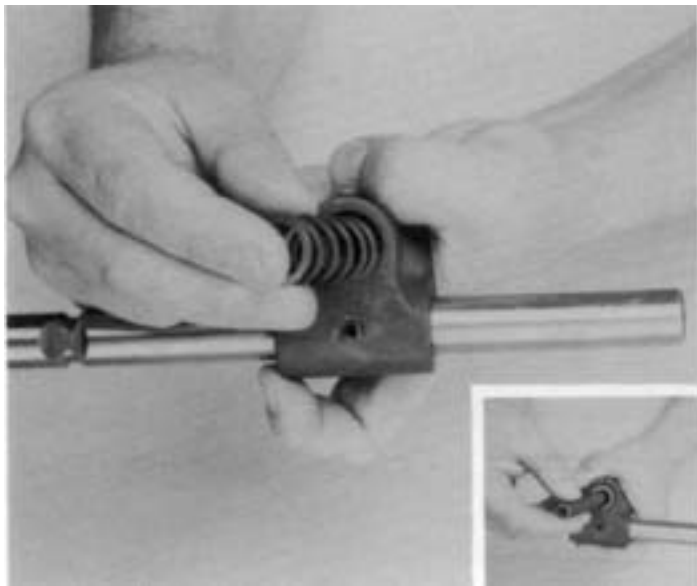

9. Install outer reverse plunger spring. Install inner reverse plunger spring (inset).



11. Place the shift yoke in a hand press. Depress retaining washer and spring and install the snap ring.

CAUTION

THE SNAP RING AND RETAINER WILL BE UNDER SPRING TENSION AS INSTALLED.

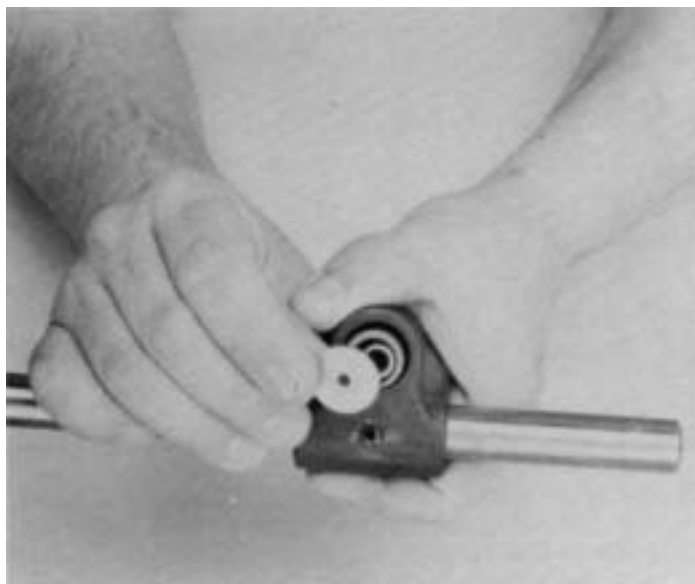

10. Install reverse plunger retaining washer.



12. Install the reverse light switch pin in the shift bar housing.

DISASSEMBLY AND REASSEMBLY SHIFTING CONTROLS

SHIFT BAR HOUSING ASSEMBLY (con't.)

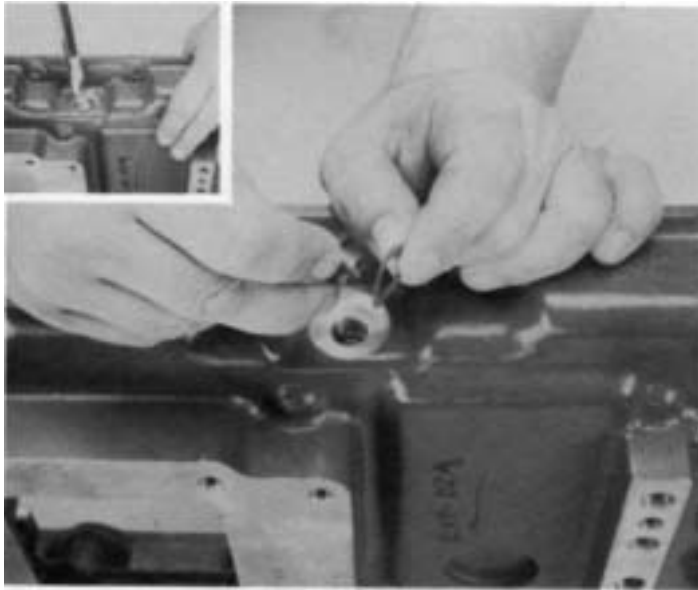

13. Install reverse light switch or plug and gasket in shift bar housing. Tighten reverse light switch or plug (inset).

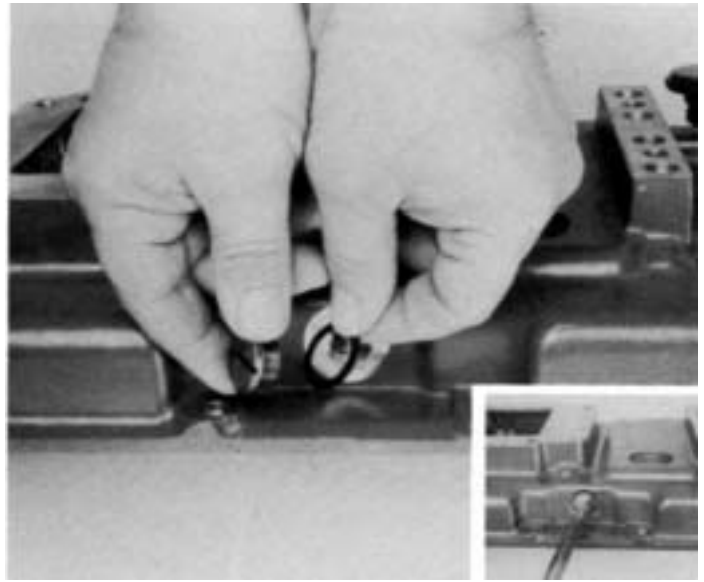

15. Install the neutral light switch or plug and gasket in shift bar housing. Tighten neutral light switch or plug in shift bar housing (inset).

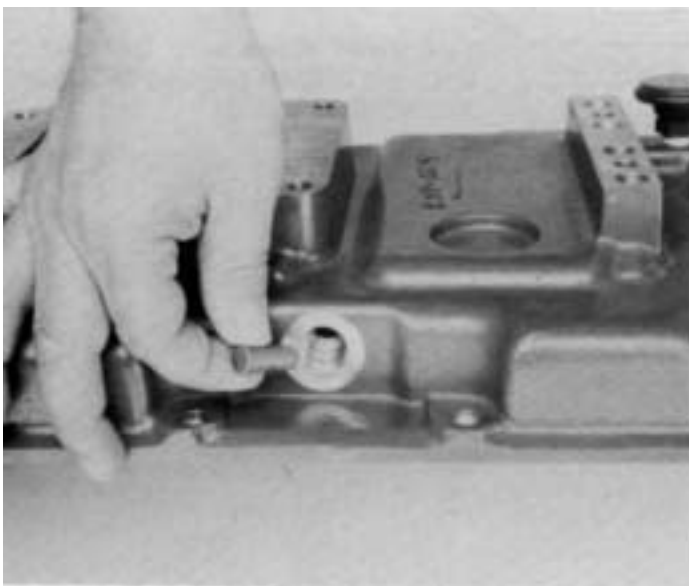

14. Install the neutral light switch pin in the shift bar housing.

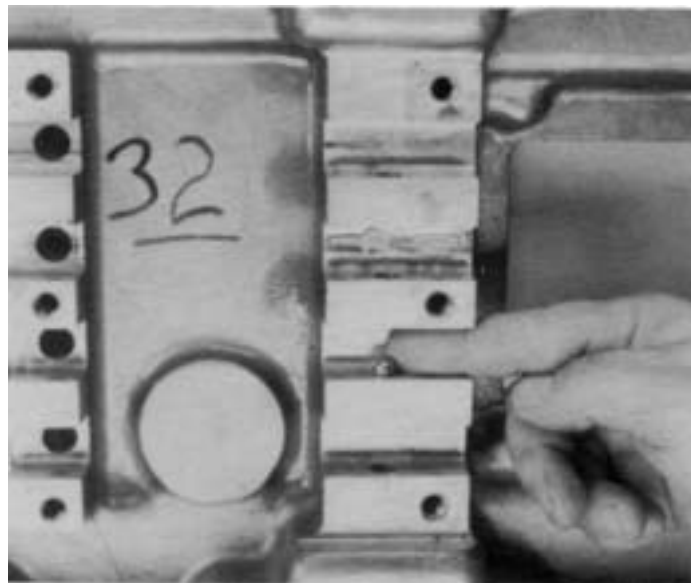

16. Install interlock balls in the shift bar housing in the following sequence: position two interlock balls in the 1st-2nd crossbore; 3rd-4th crossbore; and the 5th-6th crossbore.

DISASSEMBLY AND REASSEMBLY SHIFTING CONTROLS

SHIFT BAR HOUSING ASSEMBLY (con't.)

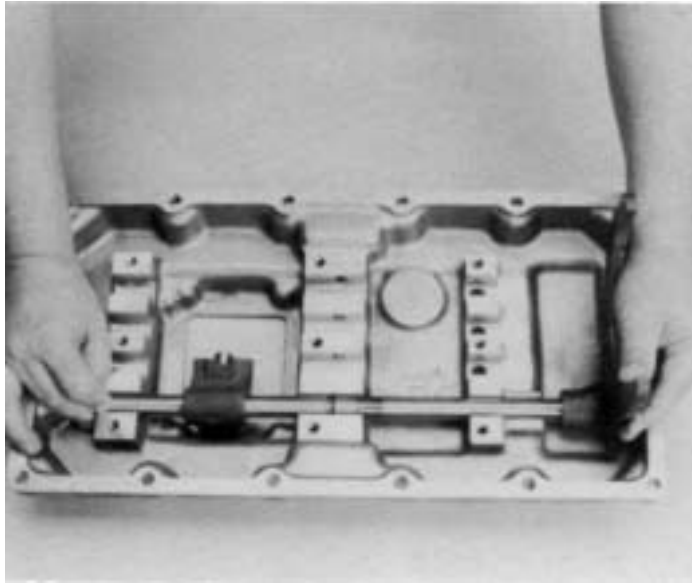

17. Place shift bar housing on a work bench as shown, and install the reverse yoke assembly in position as shown.

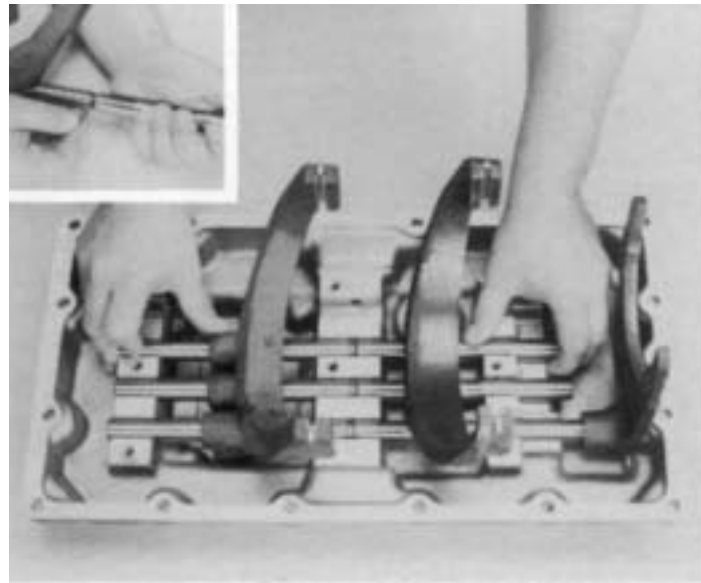

19. Install interlock pin in the 3rd-4th yoke and rail assembly (inset). Position the assembly in shift bar housing.

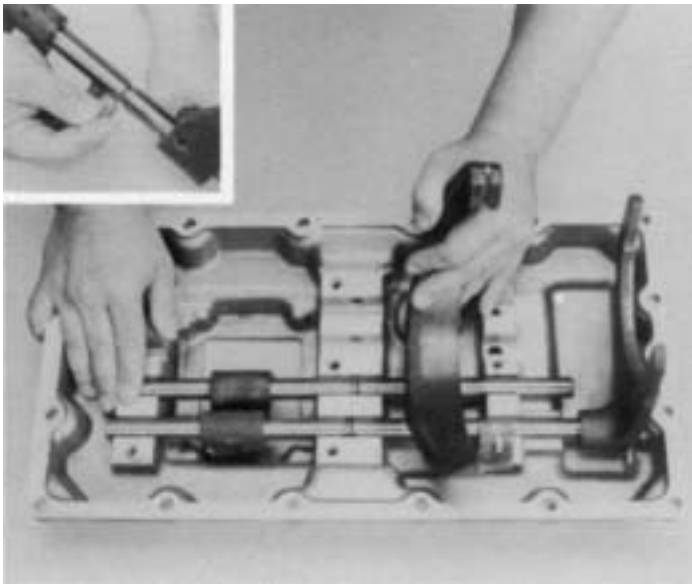

18. Install interlock pin in the 1st-2nd yoke assembly (inset). Position 1st-2nd yoke and rail assembly in shift bar housing.

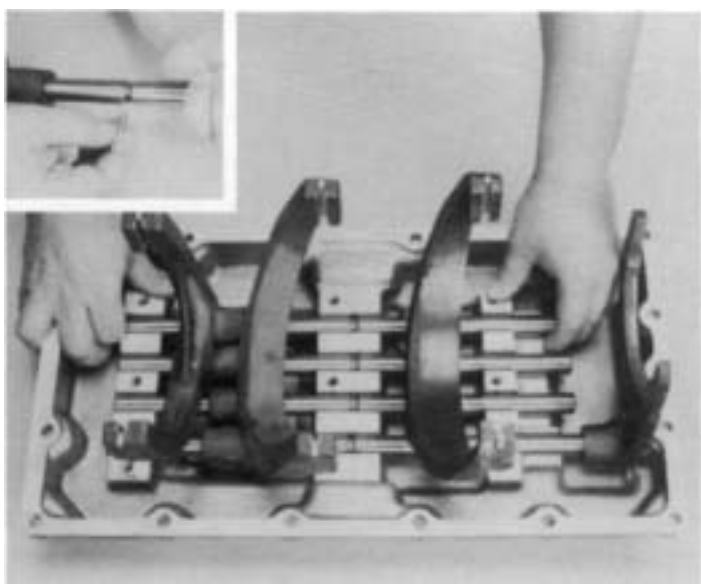

20. Install interlock pin in the 5th-6th yoke assembly (inset). Position the assembly in shift bar housing.

DISASSEMBLY AND REASSEMBLY SHIFTING CONTROLS

SHIFT BAR HOUSING ASSEMBLY (con't.)

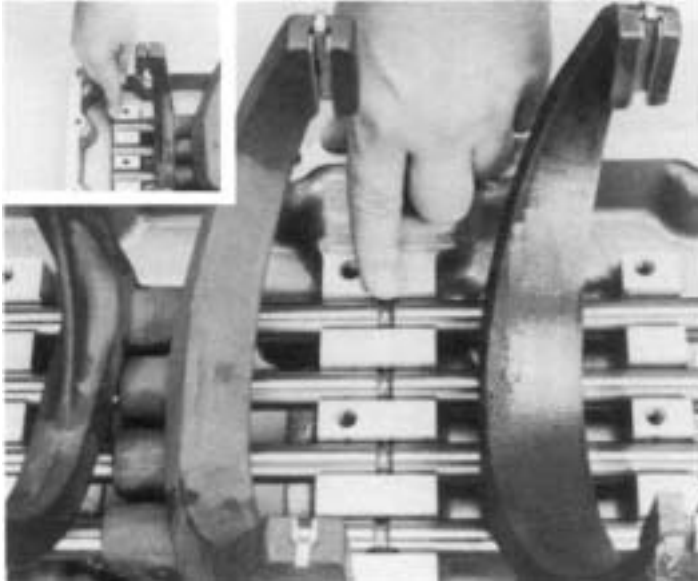

21. Make sure all yoke assemblies are in the neutral position as shown (inset) and interlock pins are aligned to interlock ball crossbones.

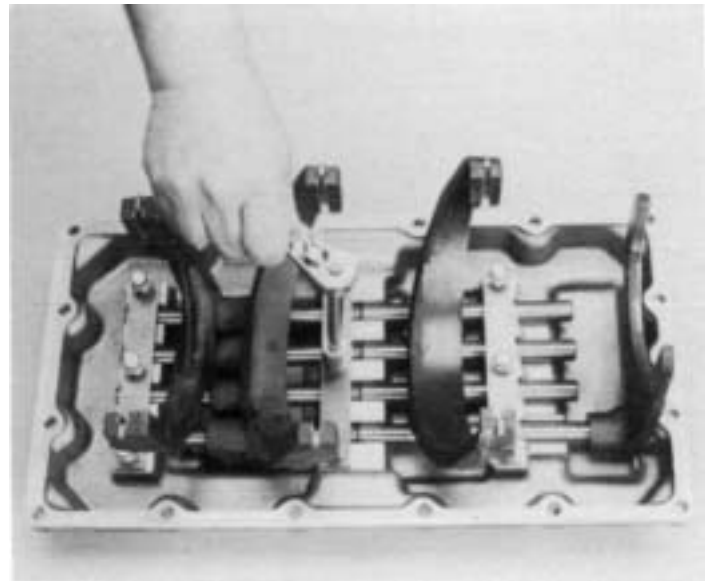

23. Install nine cap screws in shift bar housing as shown and tighten to the recommended torque.

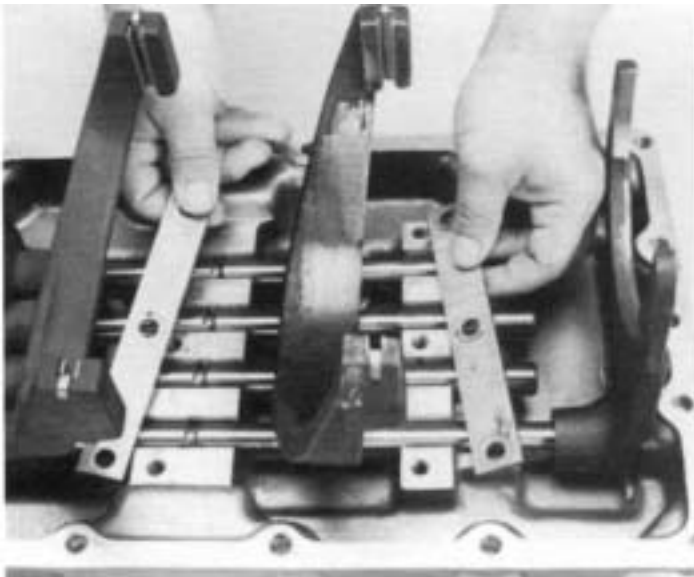

22. Position the three retainer plates in shift bar housing.

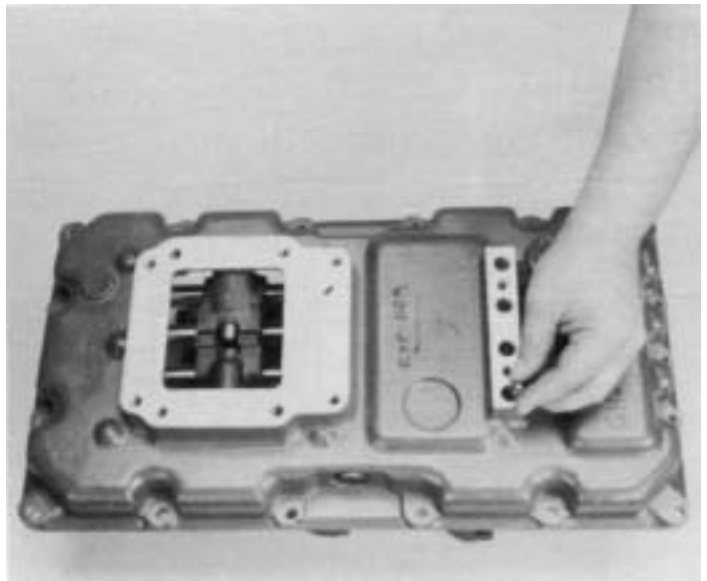

24. Position shift bar housing as shown and install four interlock balls.

DISASSEMBLY AND REASSEMBLY SHIFTING CONTROLS

SHIFT BAR HOUSING ASSEMBLY (con't.)

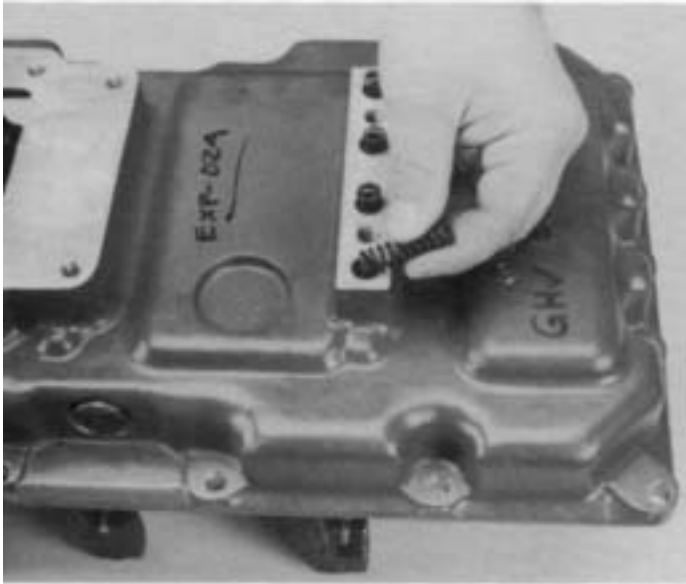

25. Install the four interlock springs.

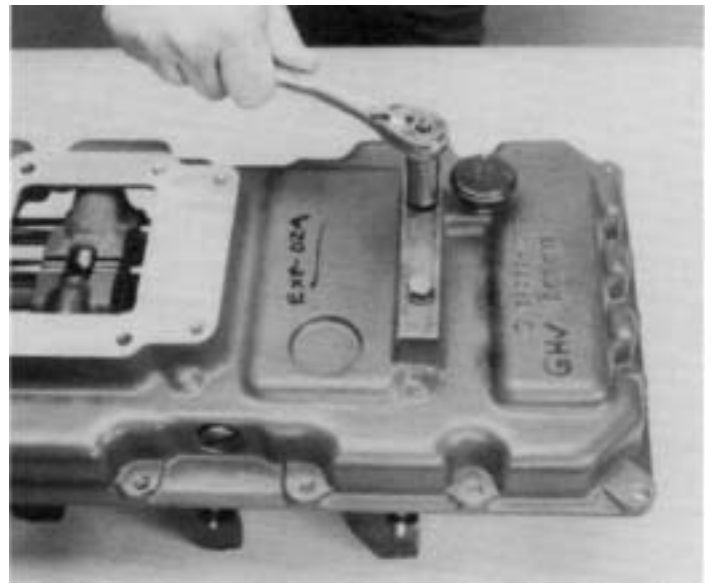

27. Install two cap screws and tighten to recommended torque.

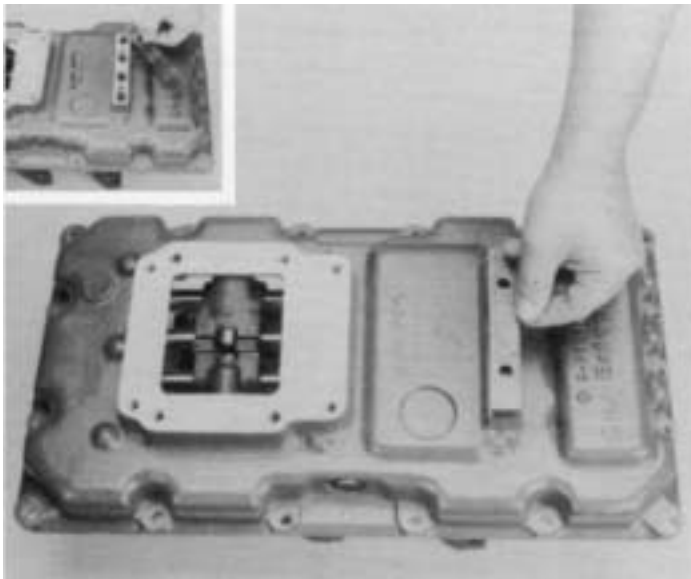

26. Install gasket (inset) and retainer plate.

REMOVAL - OUTPUT YOKE AND CLUTCH HOUSING

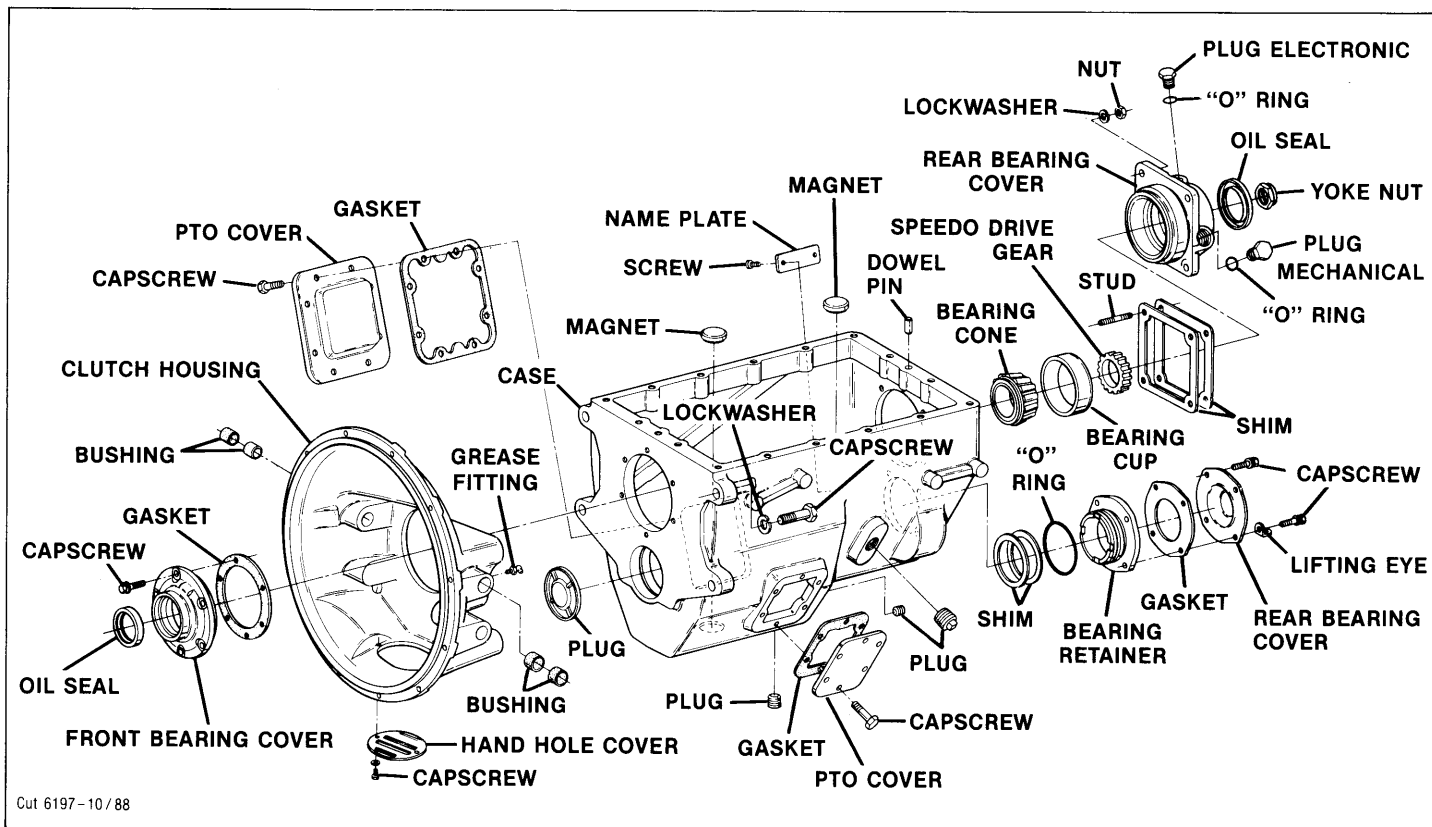

A. Removal of the Clutch Housing

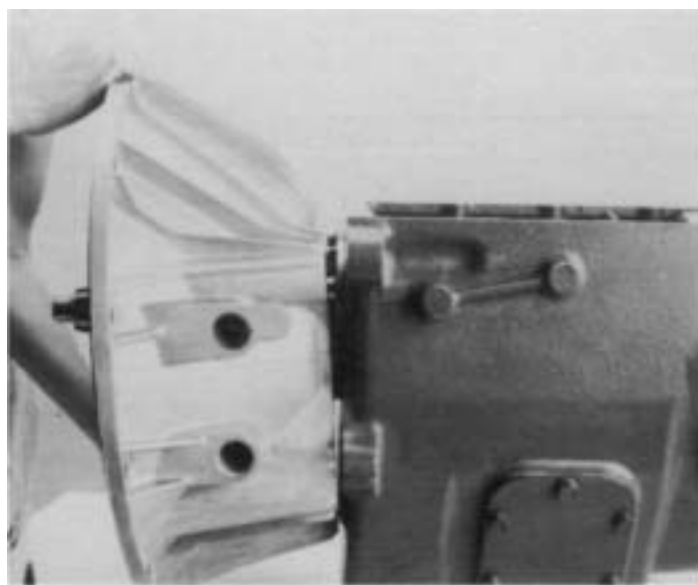
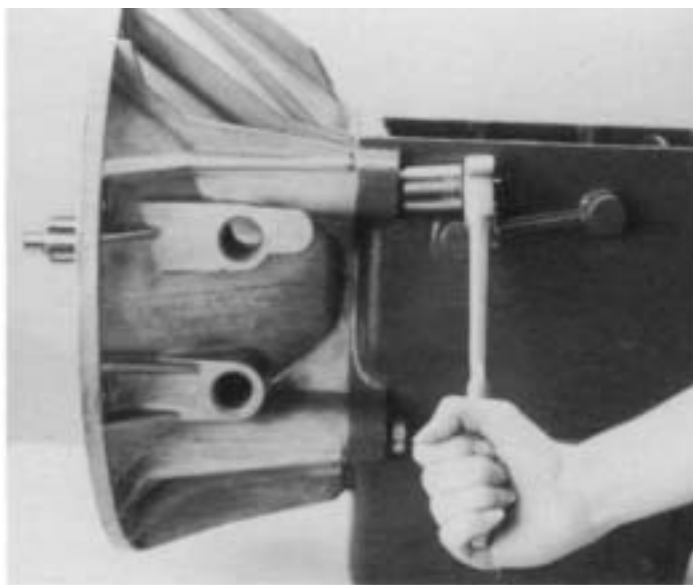

1. Remove the four clutch housing retaining bolts from the case and clutch housing as shown.

2. Jar clutch housing with a rubber mallet and pull the clutch housing from transmission case.

REMOVAL - OUTPUT YOKE AND CLUTCH HOUSING

B. Removal of the Output Yoke

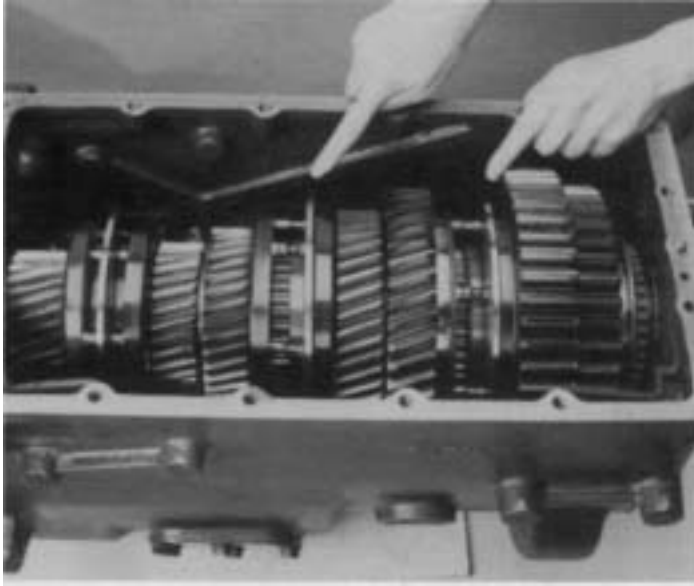

1. Lock the transmission by engaging two mainshaft gears.



3. Remove the output yoke from the output shaft.

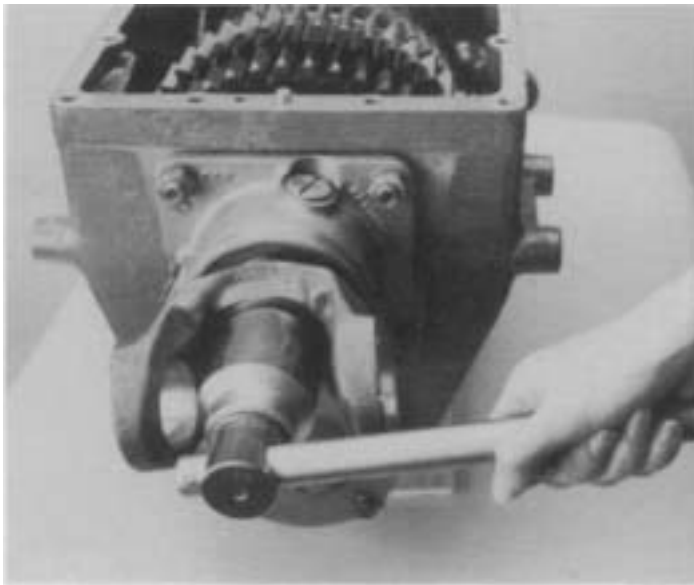

2. Use a breaker bar to turn the nut from the output shaft.

DISASSEMBLY - TRANSMISSION

A. Removal & Disassembly of the Input Shaft Assembly

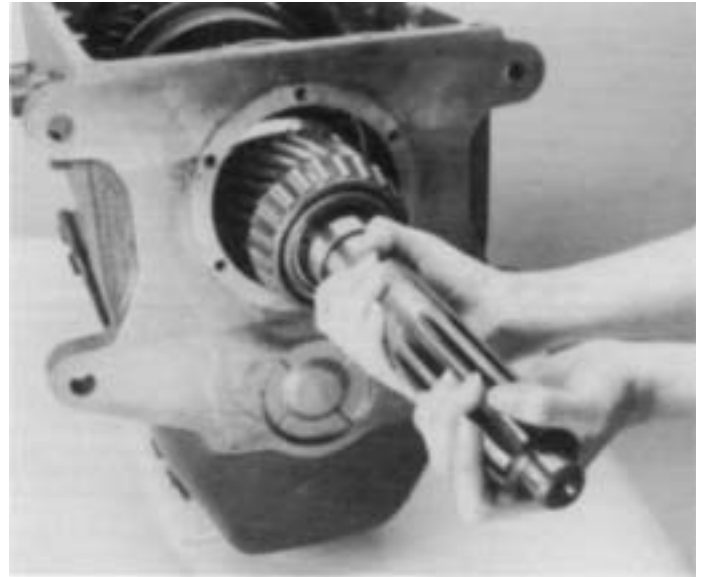
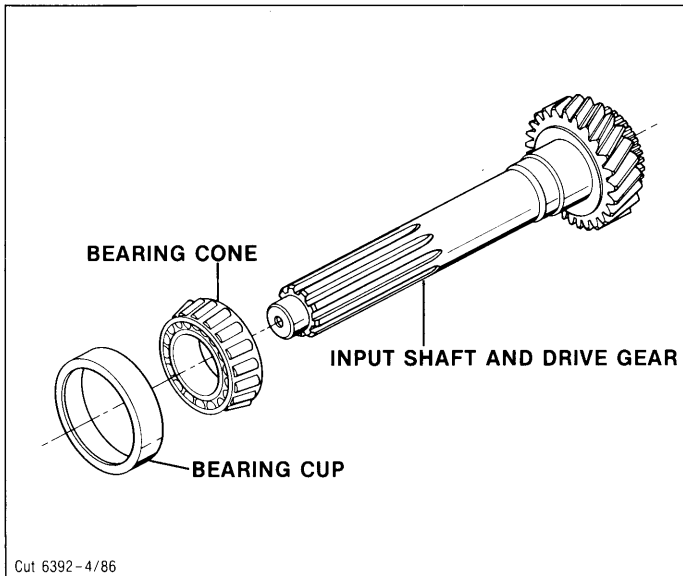

2. Remove input shaft assembly from transmission.

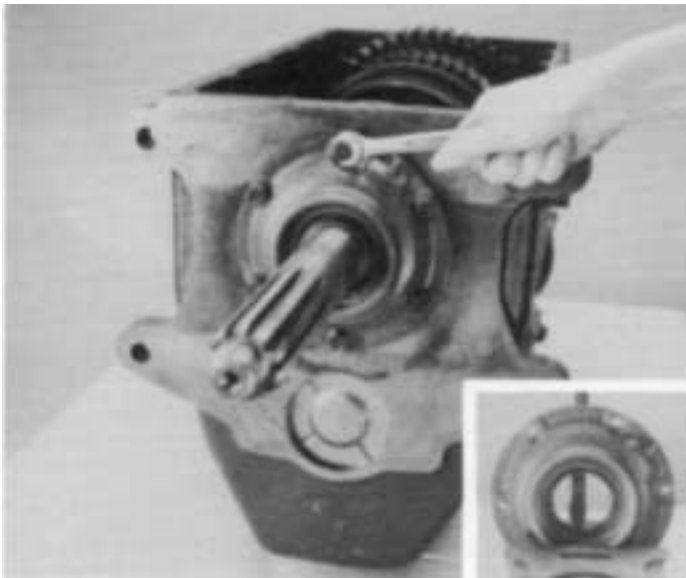

1. Turn out six capscrews, jar front bearing cover with a rubber mallet and remove. If necessary remove oil seal from cover (inset).



3. Using a chisel, remove bearing cage and rollers. install bearing puller and remove bearing race from input shaft.

DISASSEMBLY - TRANSMISSION

B. Removal & Disassembly of the Mainshaft

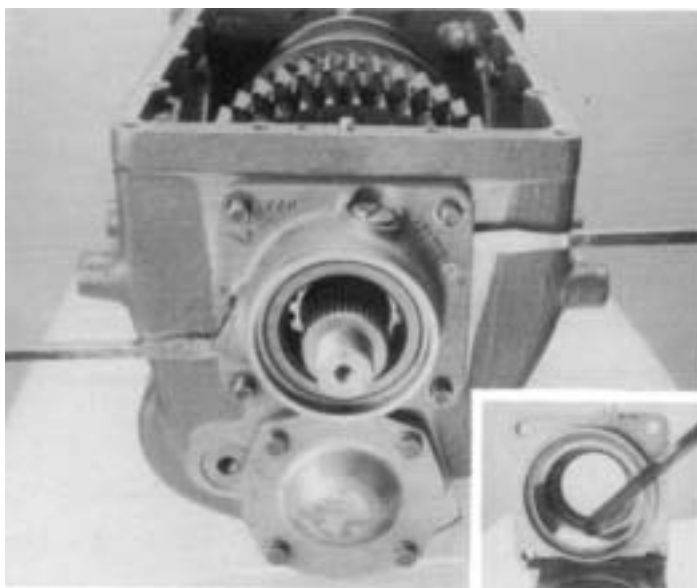
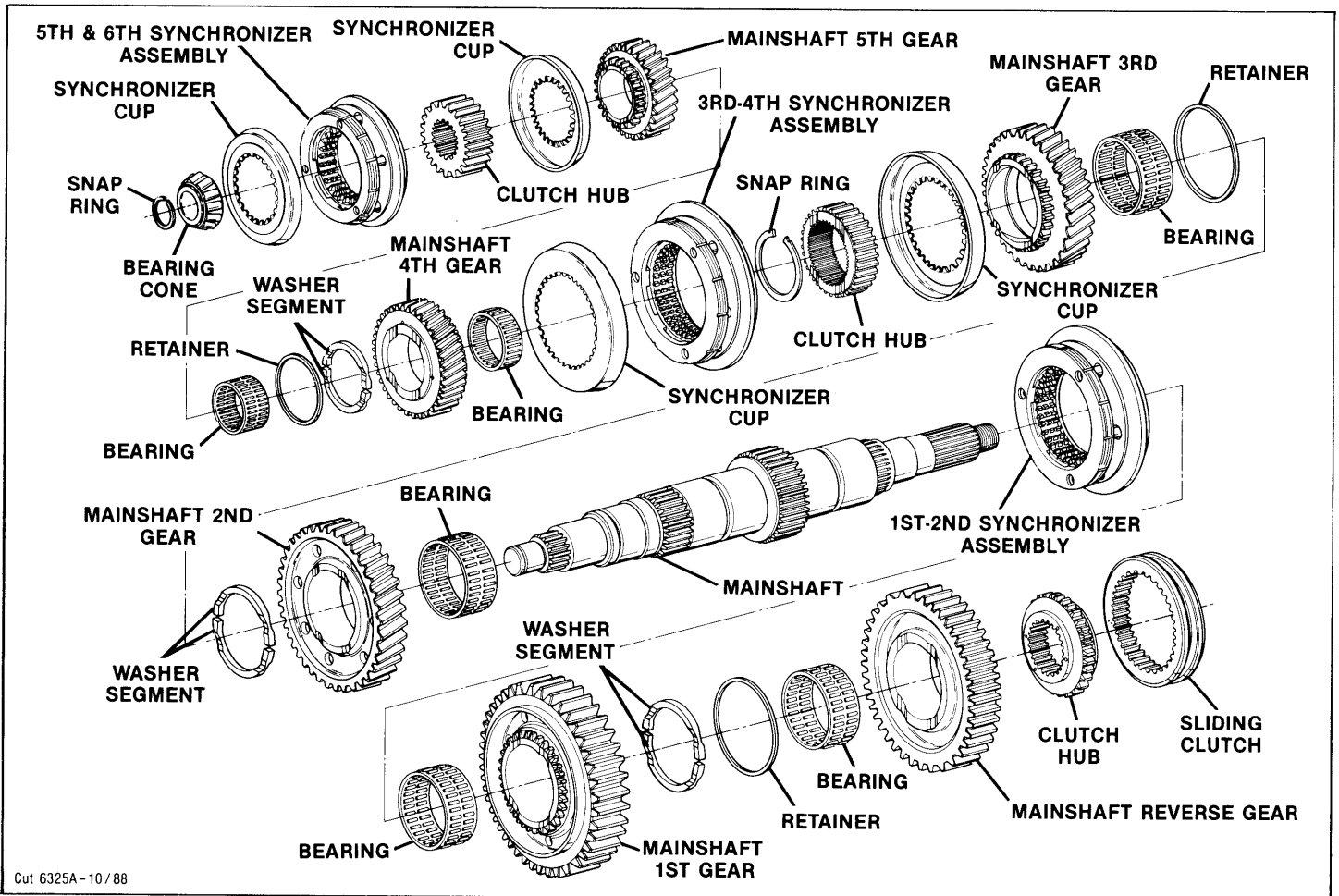

1. Turn out four retaining nuts and lockwashers. Using screwdrivers in notches, remove rear bearing cover. If necessary remove oil seal from cover (inset).

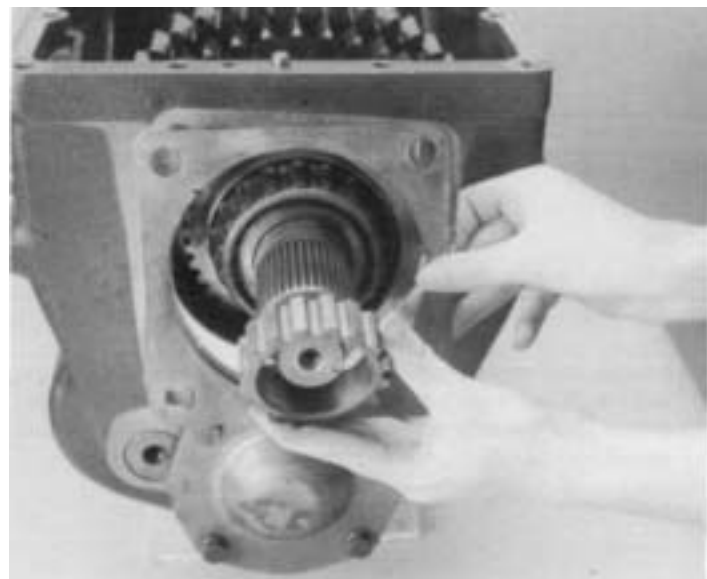

2. Remove shims and speedometer drive gear or rotor.

NOTE: Shims may come off with rear bearing cover.

DISASSEMBLY - TRANSMISSION

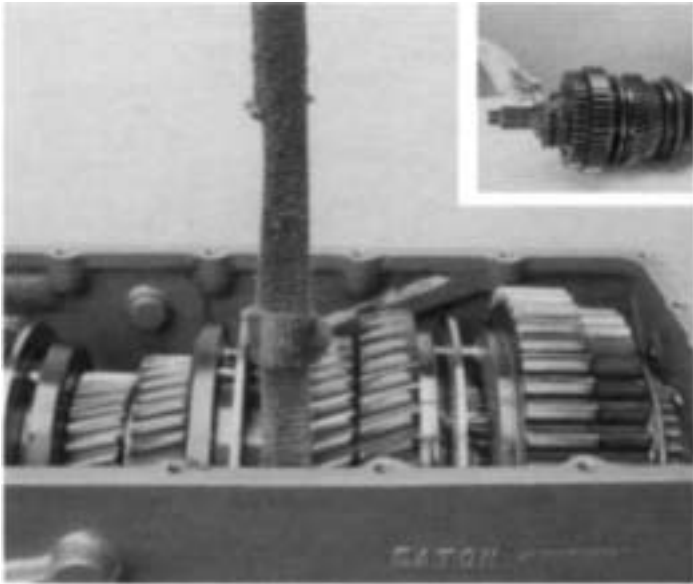

3. Wrap a sling around the 3rd-4th synchronizer assembly. Use a hoist to remove the mainshaft assembly from the case. Remove the reverse gear sliding clutch from the mainshaft (inset).

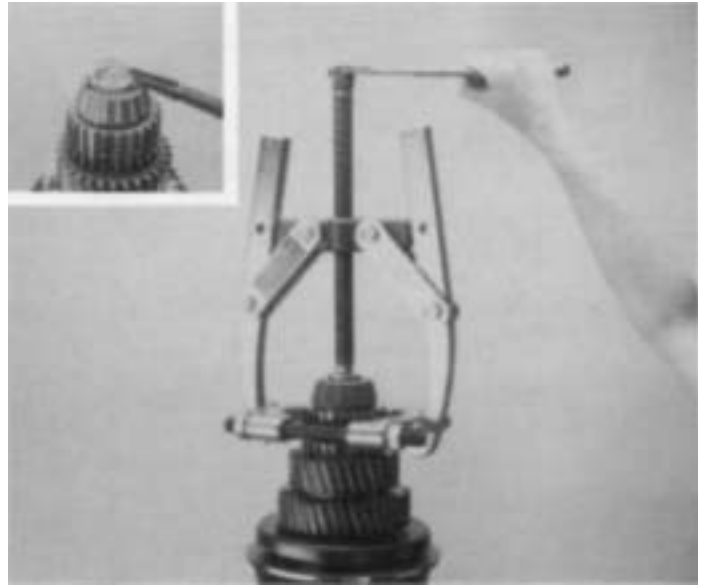

5. Remove the retaining snap ring from front of of the mainshaft (inset). Using a puller and clamp mounted behind 5th-6th speed shift hub, remove the shift hub and bearing.



4. Install the mainshaft assembly in a vise equipped with soft jaws or wood, front of shaft facing up. Remove the 5th-6th speed synchronizer assembly and synchronizer cups from the mainshaft.

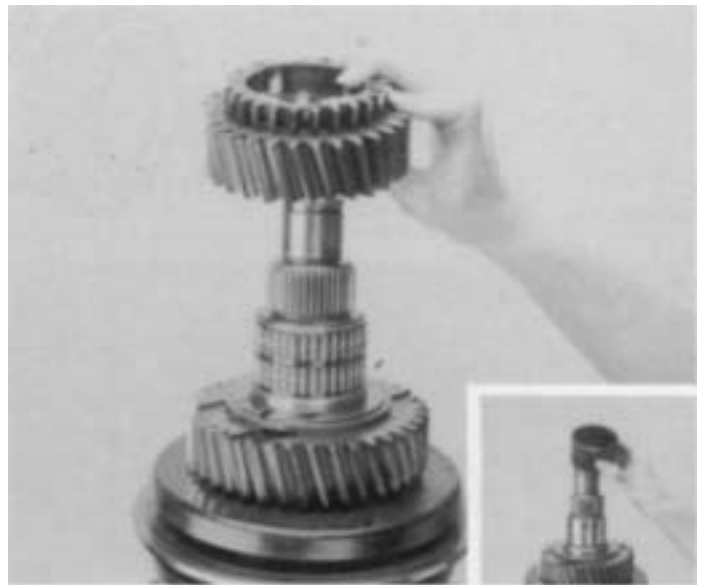

- Remove the 5th speed gear and bearings (inset) from the mainshaft.

DISASSEMBLY - TRANSMISSION

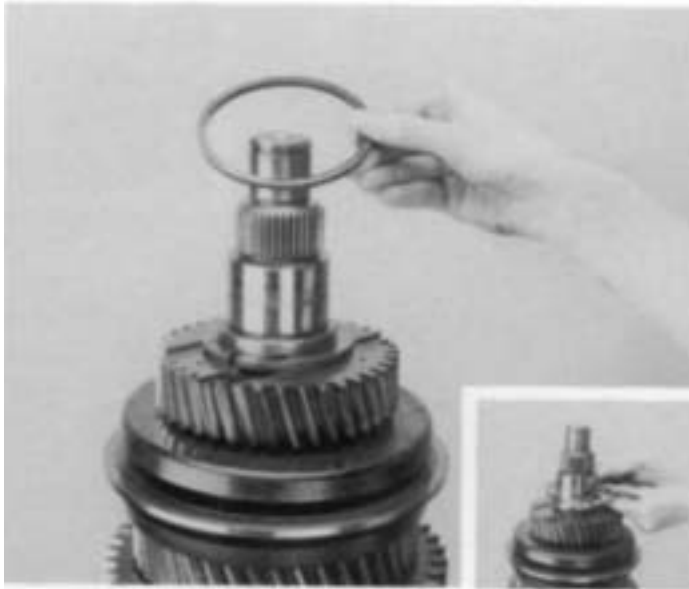

7. Remove the split washer retaining ring and split washers from the mainshaft.



9. Remove the 3rd-4th speed synchronizer assembly and synchronizer cups from the mainshaft.



8. Remove the 4th speed gear and bearings from the mainshaft.

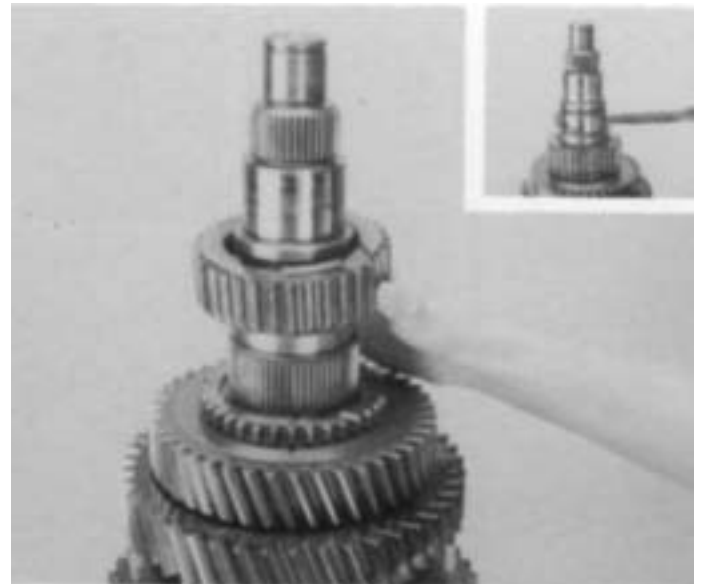

10. Remove the 3rd-4th speed shift hub retaining snap ring from the mainshaft snap ring groove (inset). Remove the 3rd-4th speed shift hub from the mainshaft.

DISASSEMBLY - TRANSMISSION

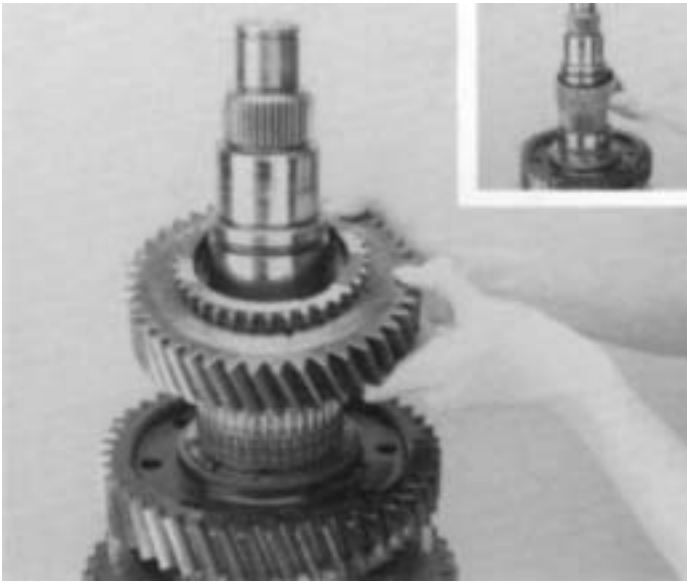

11. Remove the 3rd speed gear from the mainshaft. Remove the 3rd speed gear bearings from the mainshaft (inset).

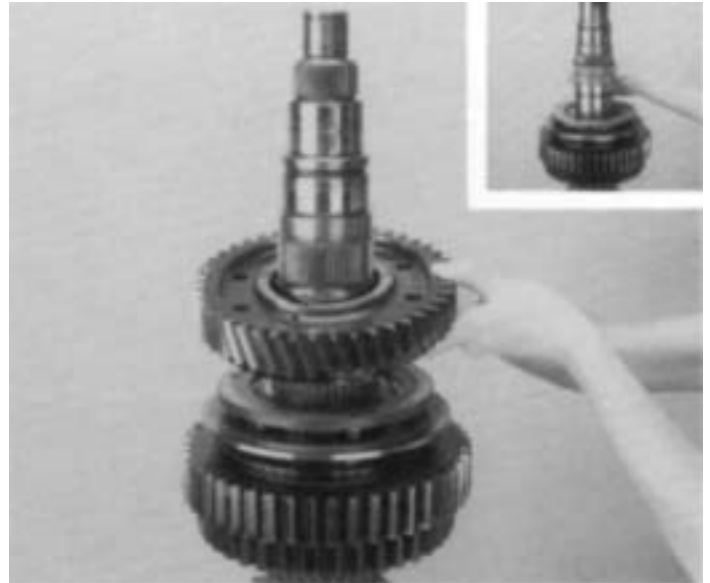

13. Remove 2nd speed gear and 2nd speed gear bearings from the mainshaft (inset).

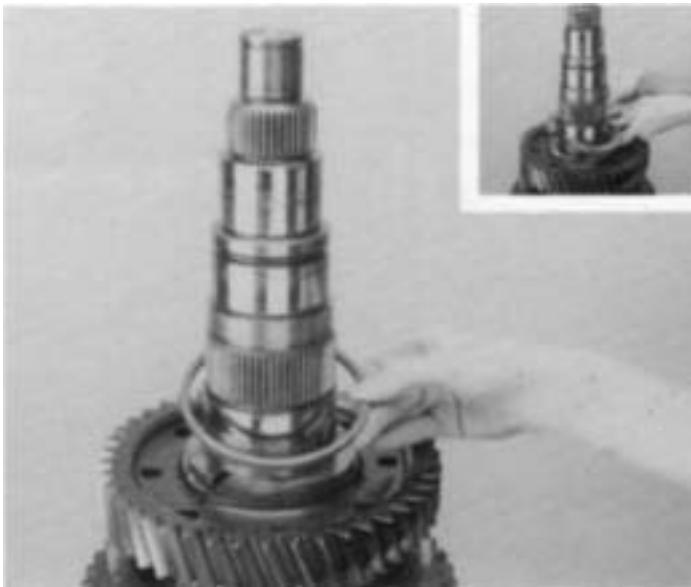

12. Remove the split washer retaining ring and split washers from the mainshaft.



14. Remove 1st-2nd speed synchronizer assembly from the mainshaft. Reposition the mainshaft in a vise, as shown, mainshaft rear facing up (inset).

DISASSEMBLY - TRANSMISSION

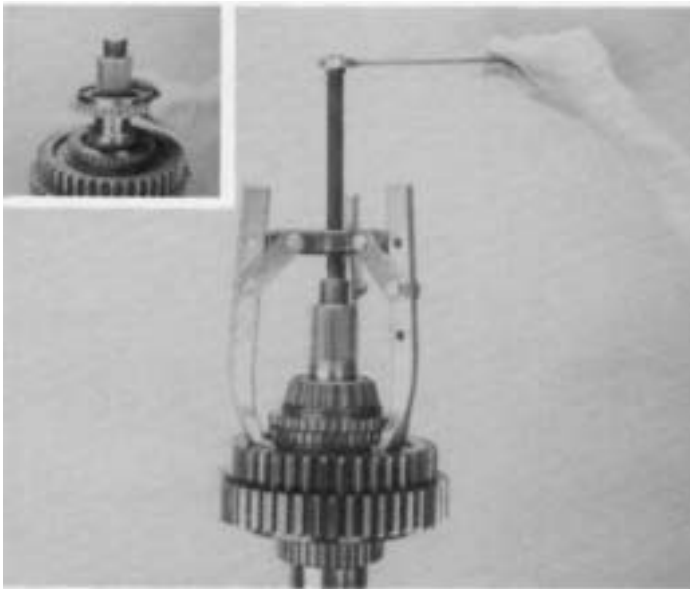

15. Using a gear puller and clamp around the reverse clutch hub, remove the reverse gear clutch hub from the mainshaft (inset).

WARNING DO NOT USE GEAR PULLER ON THE 1ST OR REVERSE SPEED GEAR. PULLING ON THESE GEARS WILL DAMAGE THE GEARS AND MAINSHAFT ASSEMBLY.

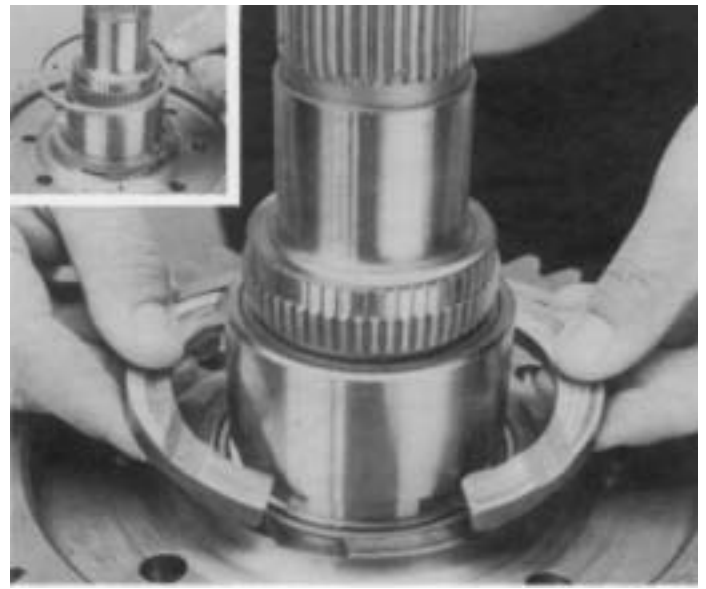

17. Remove the split washer retaining ring (inset), and the split washers from the mainshaft.

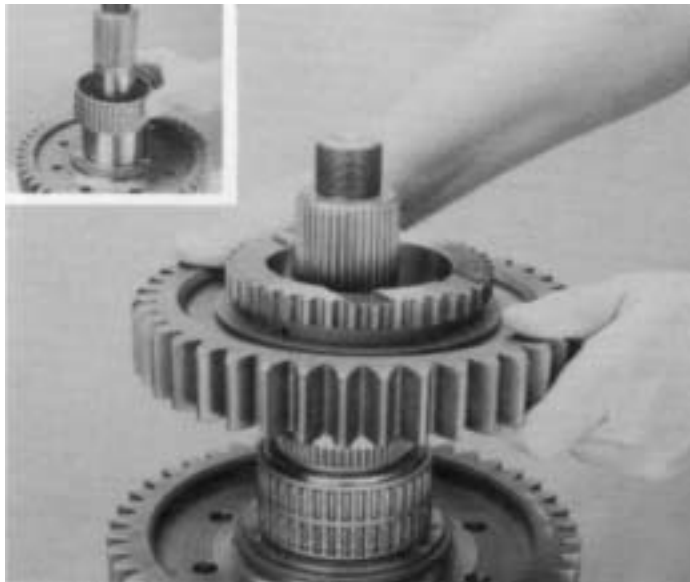

16. Remove the reverse gear and bearings (inset) from the mainshaft.

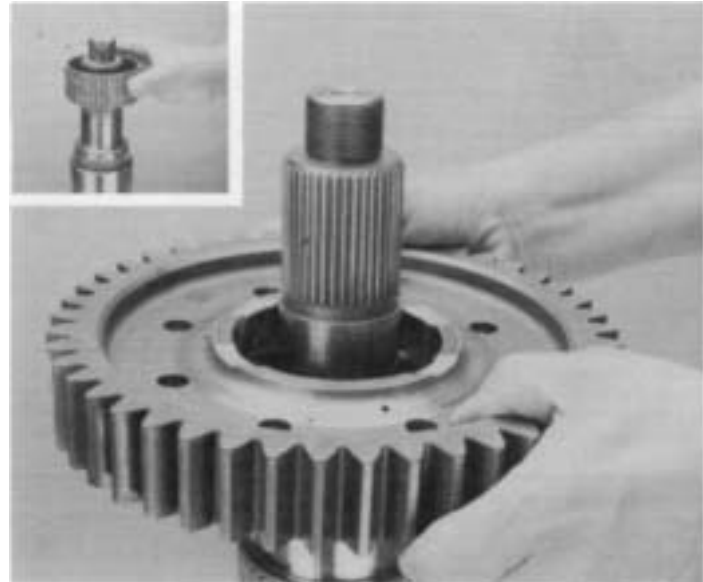

18. Remove the 1st speed gear and bearings, from the mainshaft.

DISASSEMBLY - TRANSMISSION

C. Removal and Disassembly of the Countershaft and Reverse Idler Assembly.

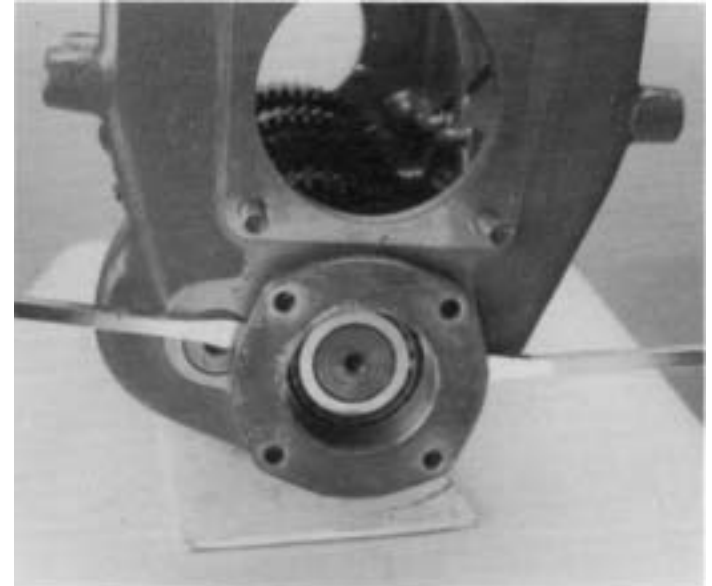
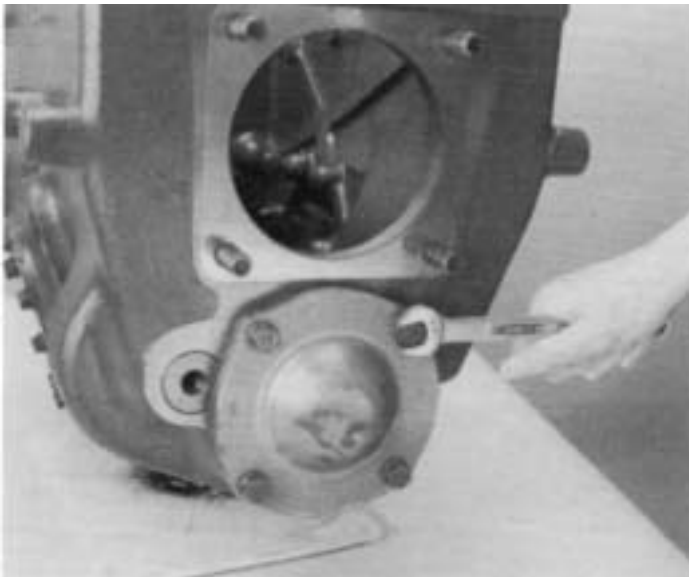
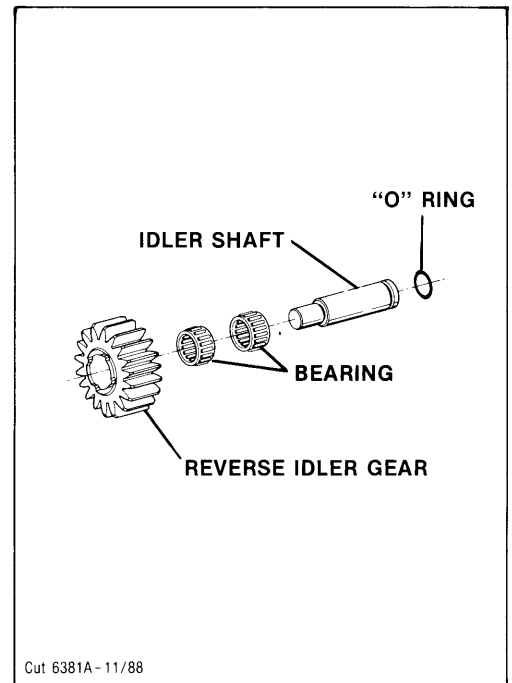
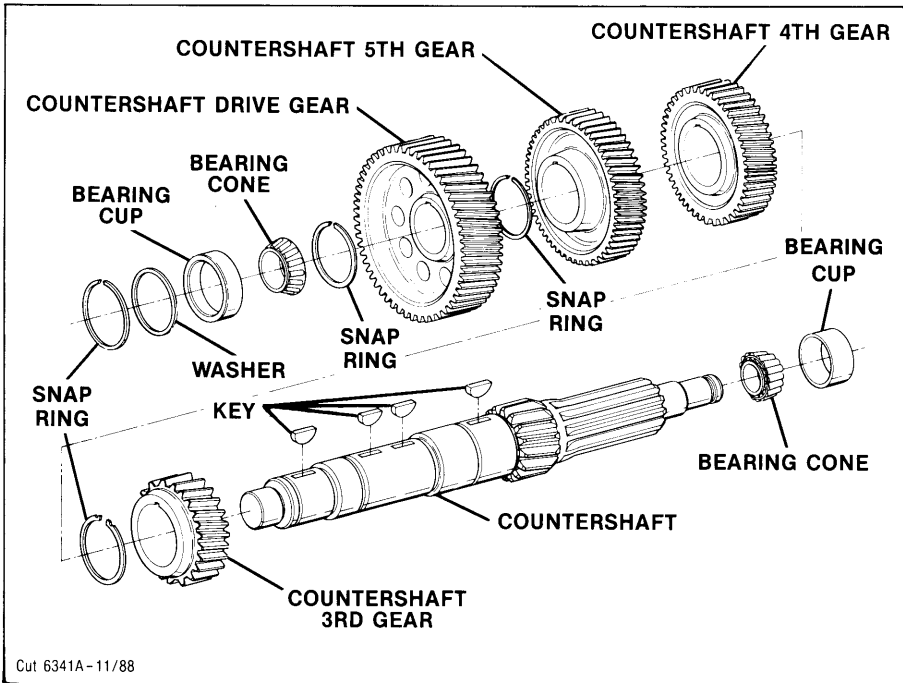

1. Remove the four retaining capscrews, and the countershaft rear bearing cover from the transmission case.

2. Jar the countershaft rear bearing housing to loosen the housing. Use two screwdrivers to pry the countershaft bearing housing from the case.

DISASSEMBLY - TRANSMISSION



3. Remove the O-ring from the O-ring groove in the countershaft rear bearing housing.

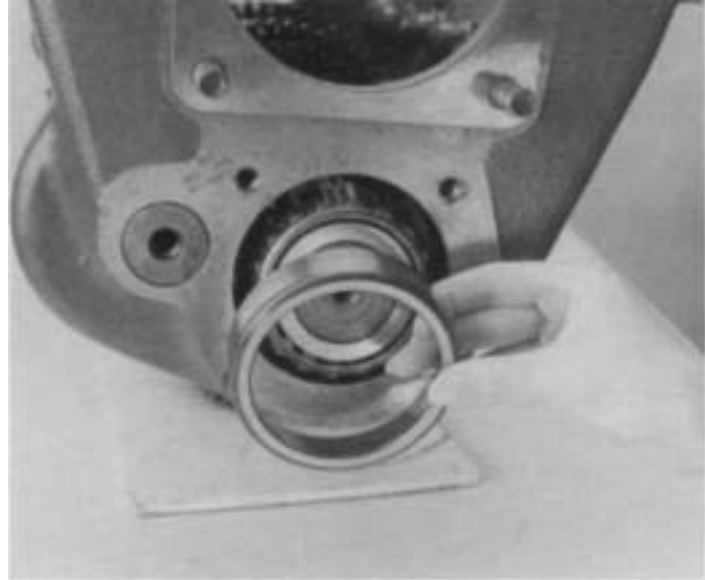

5. Remove the countershaft rear bearing outer race from the countershaft bearing case bore. The countershaft assembly can be moved to the transmission rear to assist removal of the rear bearing outer race.



4. Remove the countershaft rear bearing shims from the countershaft bearing case bore.

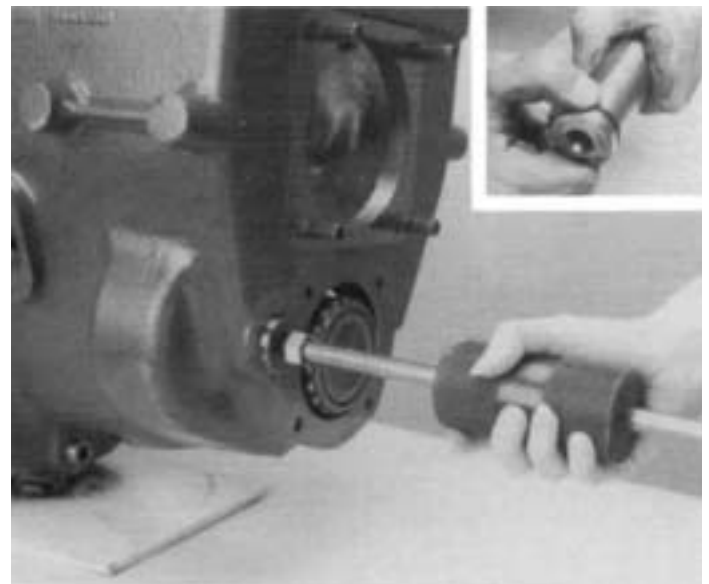

6. Using a slide hammer remove the reverse idler shaft from the case. Remove the O-ring from the O.D. of the reverse idler shaft (inset).

DISASSEMBLY - TRANSMISSION

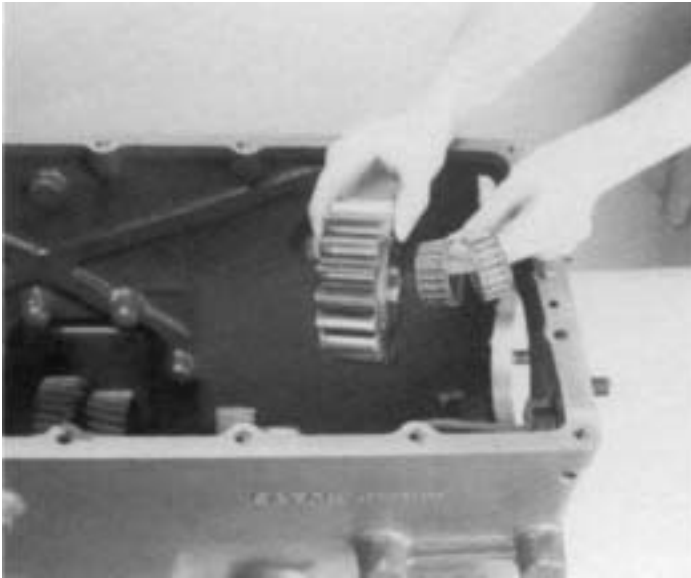

7. Remove the reverse idler and two reverse idler bearings from the transmission case.

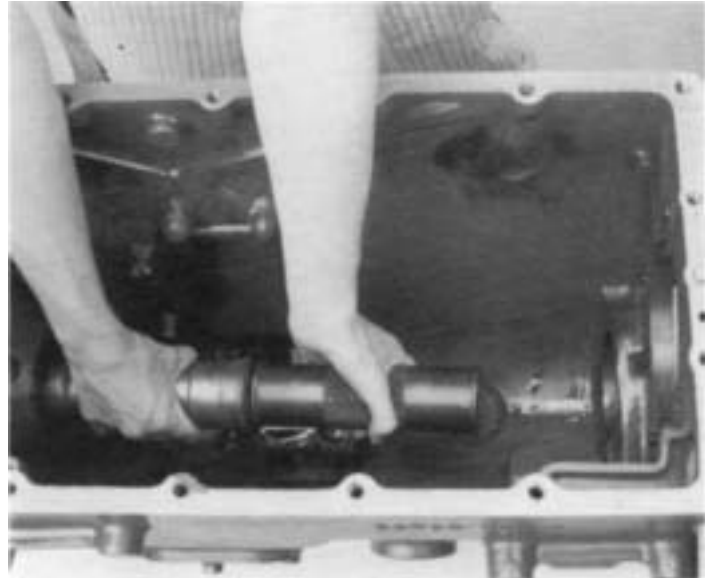

9. If the countershaft front bearing race is to be replaced, drive the countershaft front bore plug through the transmission front as shown.

WARNING THIS PROCEDURE WILL DAMAGE THE COUNTERSHAFT FRONT BORE PLUG. REPLACE THE BORE PLUG WITH A NEW PLUG UPON REASSEMBLY TO PREVENT OIL LEAKAGE.

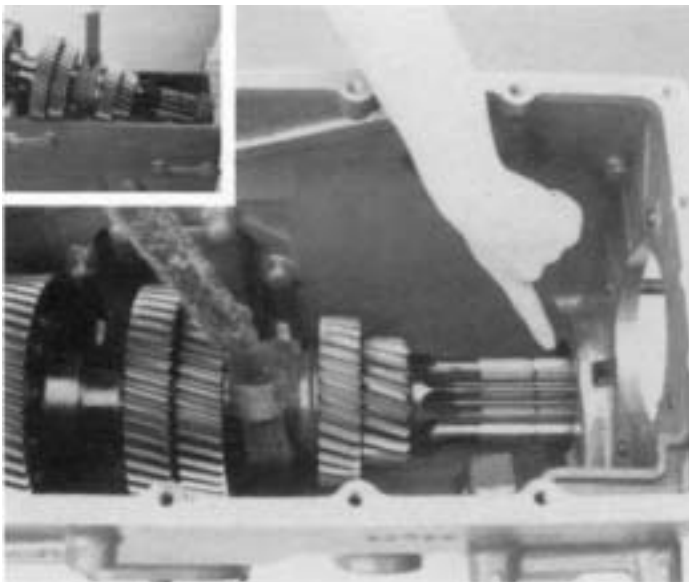

8. Move the countershaft assembly to case rear and lift the countershaft, assembly from the transmission case.

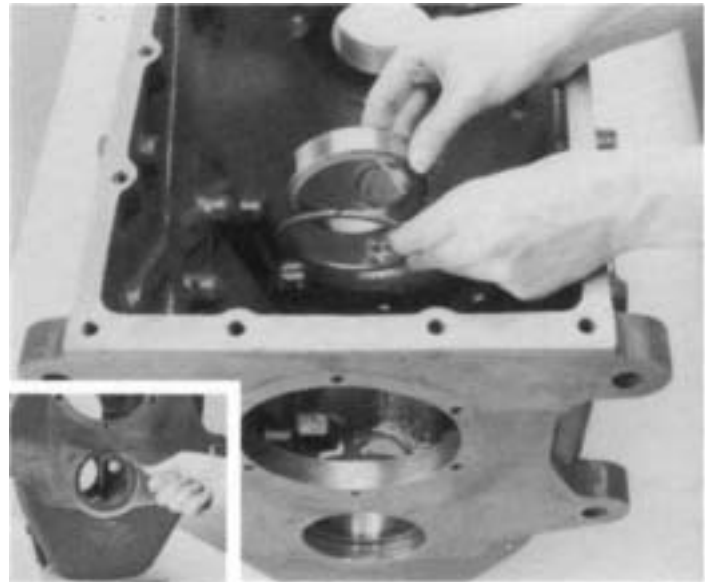

10. Remove the countershaft front bearing race retaining snap ring from the case snap ring groove (inset). Remove the retaining snap ring and the countershaft bearing race to the case rear as shown.

NOTE: If a driver has to be used to drive the countershaft front bearing race from the case BE CAUTIOUS NOT TO DAMAGE the front race bore.

DISASSEMBLY - TRANSMISSION

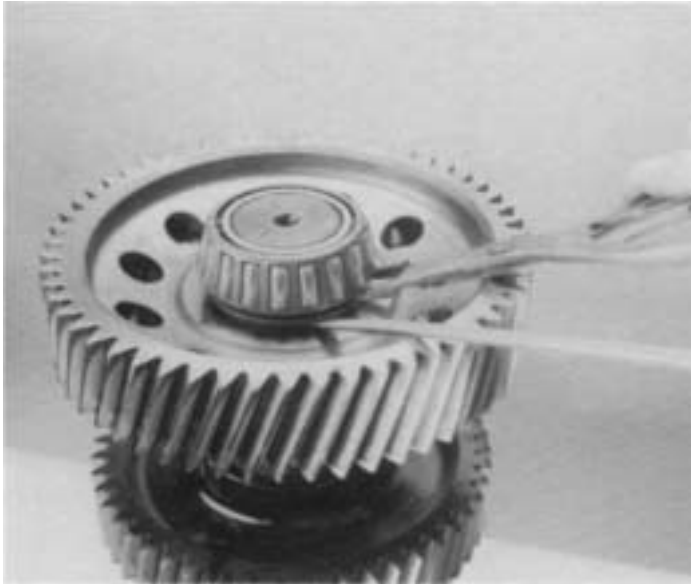

11. Using a snap ring pliers and screwdriver move the front countershaft retaining snap ring from the snap ring groove and against the front countershaft bearing.

⚠ WARNING THE SNAP RING MUST BE COMPLETELY OUT OF THE SNAP RING GROOVE TO PREVENT DAMAGE TO THE COUNTERSHAFT GEAR DURING REMOVAL.

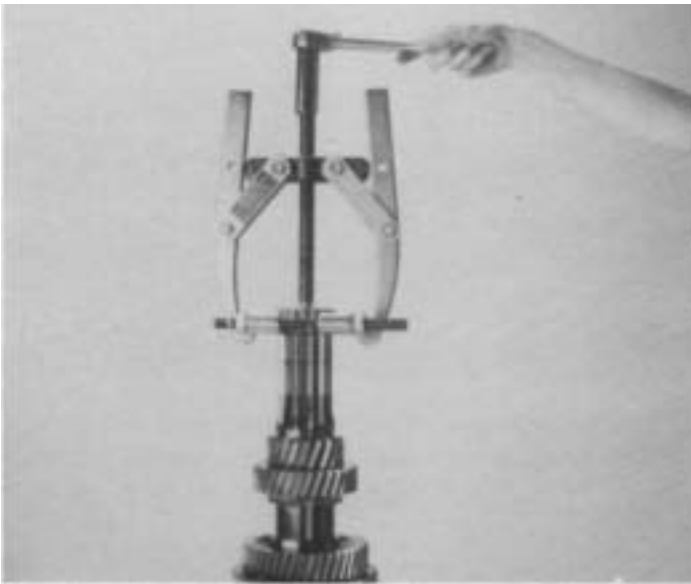

12. Use a puller to remove the countershaft rear bearing from the countershaft rear.



13. Use the rear face of the countershaft drive gear as a base, then press the countershaft drive gear, front countershaft bearing and snap ring from the countershaft assembly.



14. Remove the drive gear location key from the countershaft.

DISASSEMBLY - TRANSMISSION

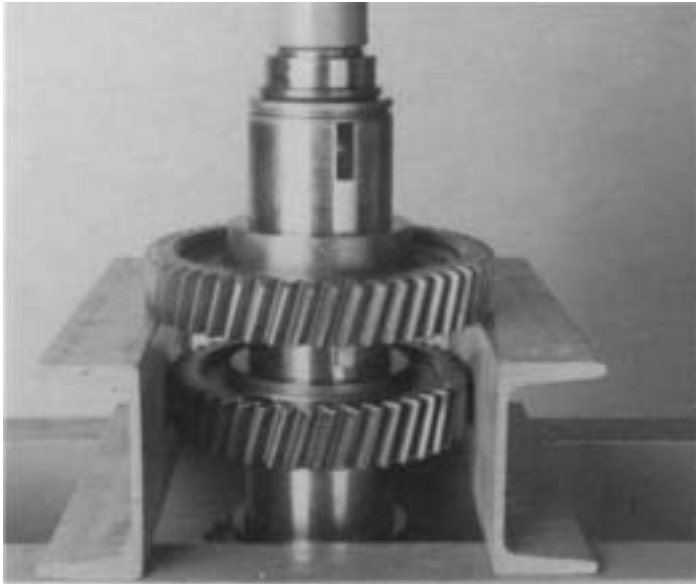

15. Using the rear face of 5th speed gear as a base, press it from the countershaft.

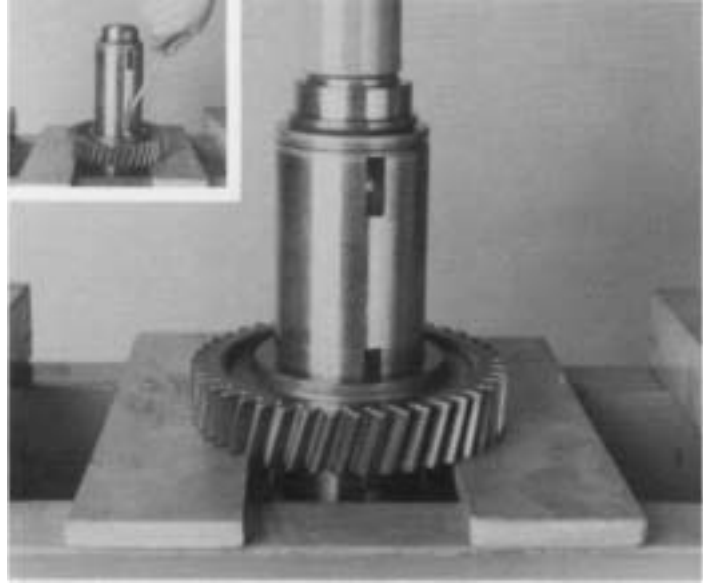

17. Remove 4th speed gear key (inset) and spacer from countershaft.



16. Remove the 5th speed gear key from shaft (inset). Using the rear face of 4th speed gear as a base, press it from the countershaft.

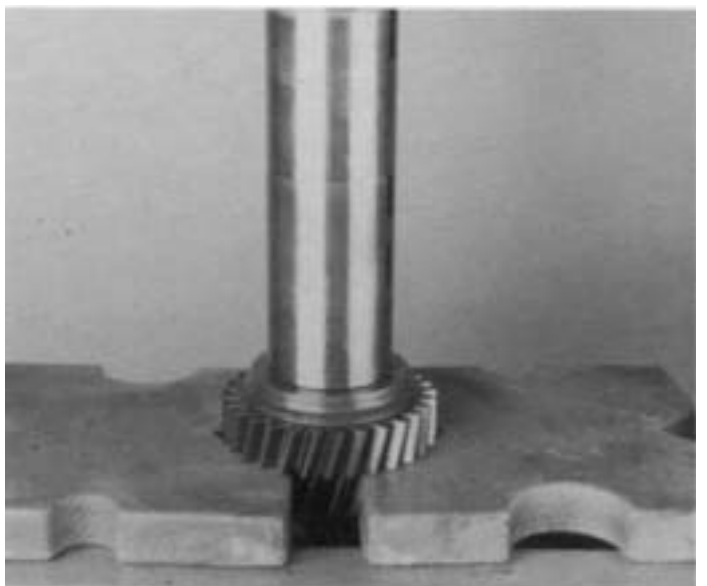

18. Use the rear face of the 3rd speed gear as a base, then press it from the shaft. If necessary, remove 3rd speed gear key from shaft.

REASSEMBLY - TRANSMISSION

A. Reassembly and Installation of the Countershaft Assembly

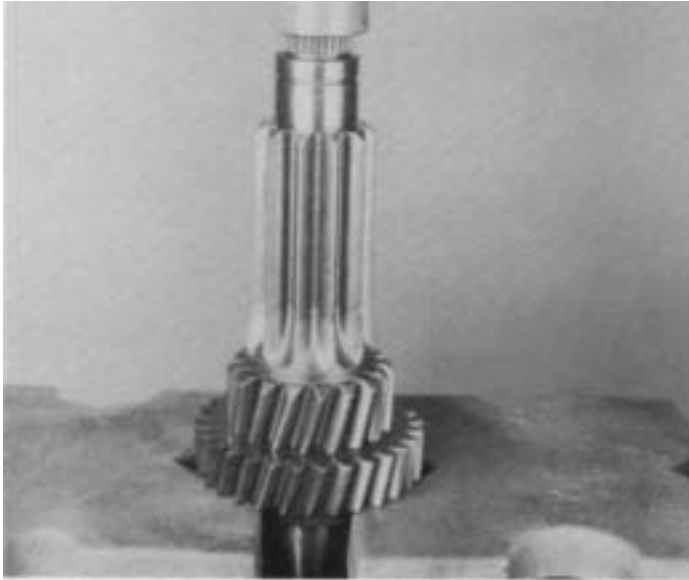

1. If previously removed, install 3rd speed gear key, Align keyway of gear with key in countershaft and press 3rd speed gear on shaft, long hub of gear to front of countershaft.

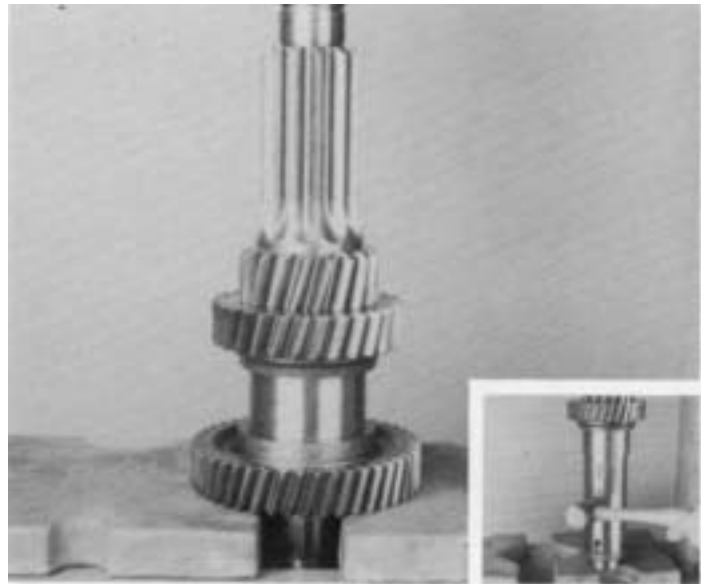

2. Install spacer and 4th and 5th countershaft key (inset). Align keyway of gear to key in countershaft and press 4th speed gear on shaft, long hub of gear to the rear.

REASSEMBLY - TRANSMISSION

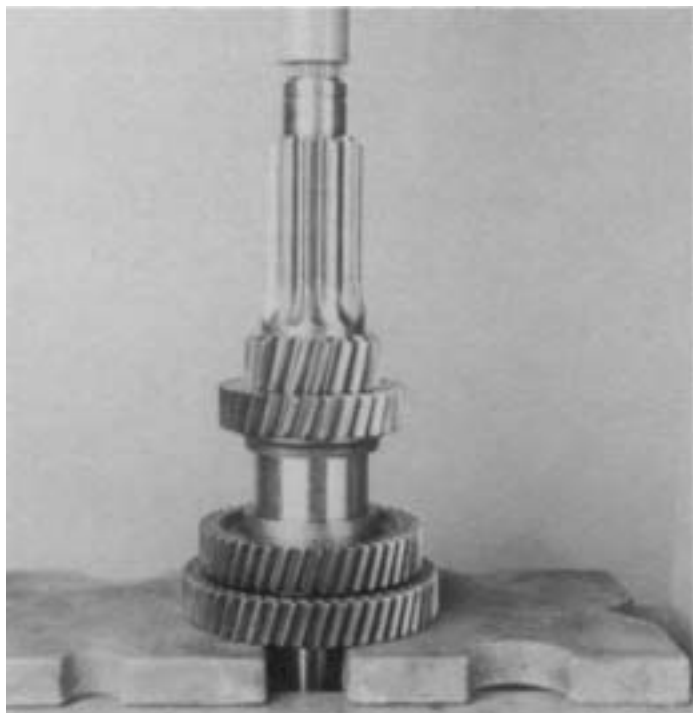

3. Align keyway of 5th speed gear to key on shaft. Press 5th gear on, long hub of gear to the front of the countershaft.

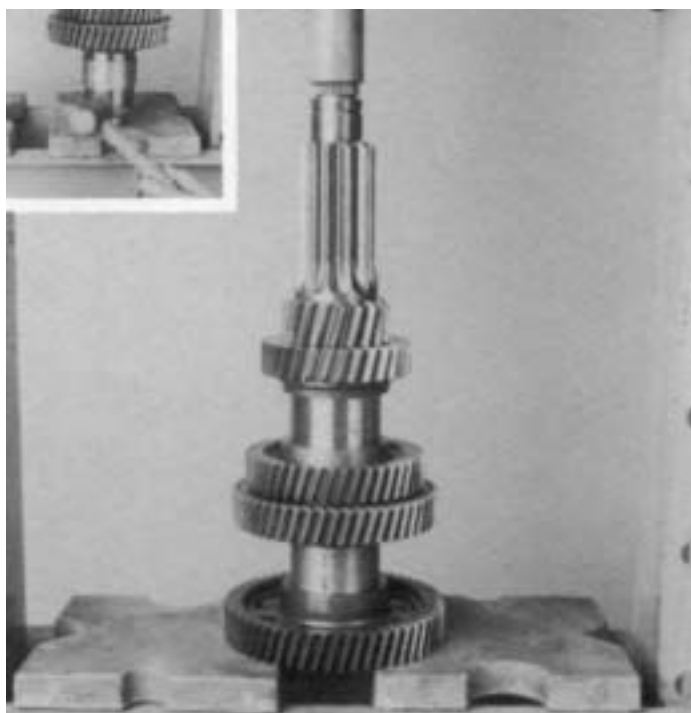

4. Install spacer and drive gear countershaft key (inset). Align keyway of gear to key in countershaft and press drive gear on shaft, long hub of gear to the rear.

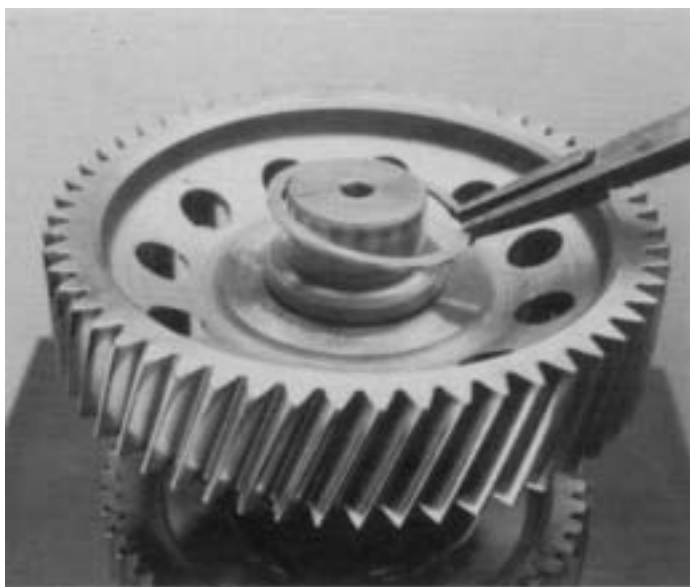

5. Install snap ring in groove at front of countershaft.

REASSEMBLY - TRANSMISSION

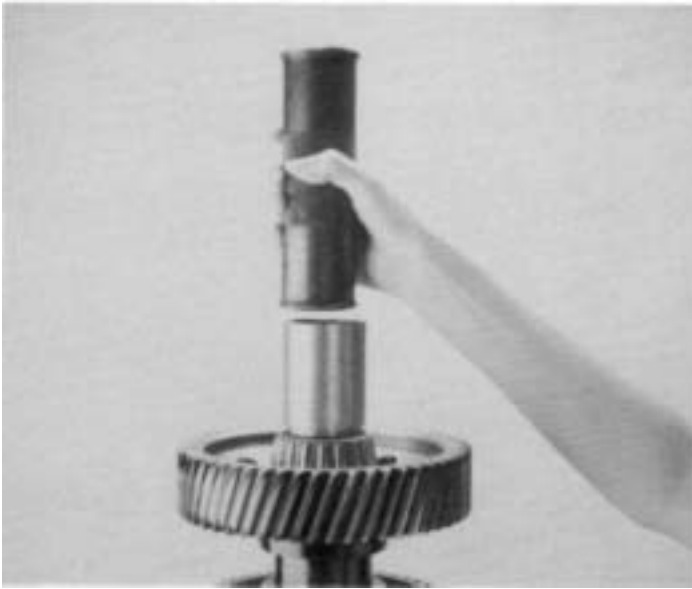

6. Using the proper size bearing driver, install the countershaft front bearing on the countershaft front.

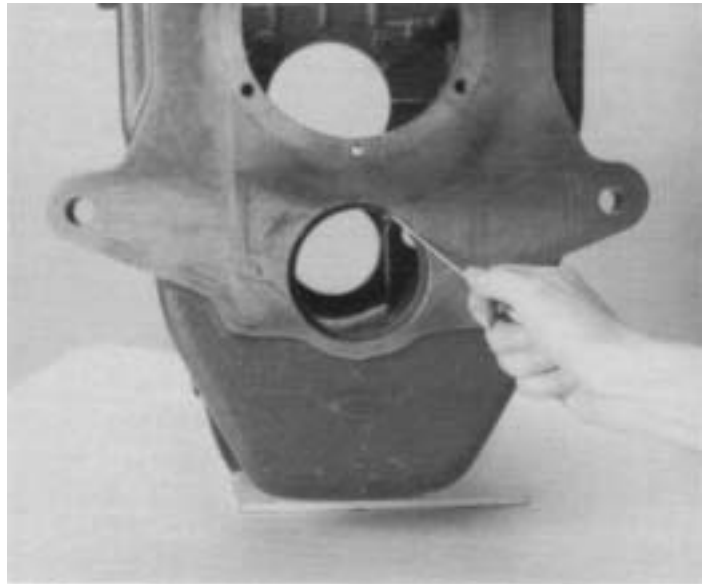

8. If previously removed, install the countershaft front bearing race snap ring in the case.



7. Using the proper size bearing driver, install the countershaft rear bearing on the countershaft rear. Make sure the bearing is seated against the countershaft.

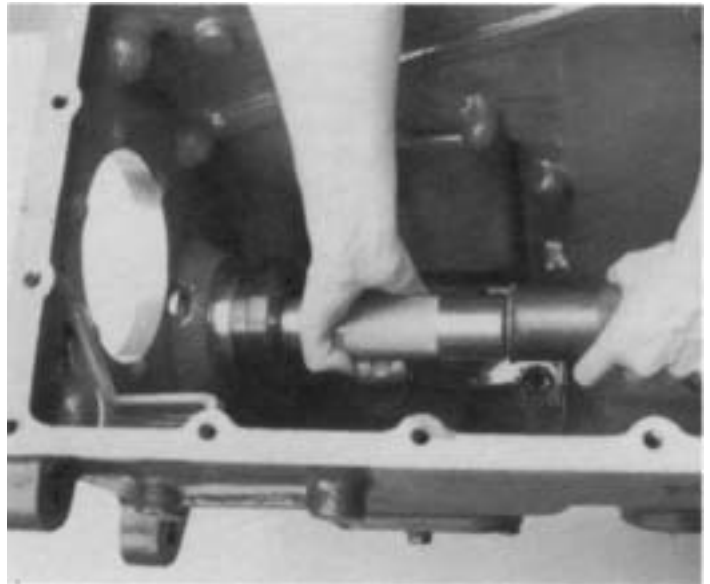

9. With the proper size bearing driver, install the countershaft front bearing race in the countershaft front bearing bore and against the retaining snap ring.

REASSEMBLY - TRANSMISSION

⚠ WARNING DO NOT REPLACE A DAMAGED, BENT, OR DENTED COUNTERSHAFT FRONT BORE PLUG. USE A NEW BORE PLUG TO PREVENT OIL LEAKAGE.

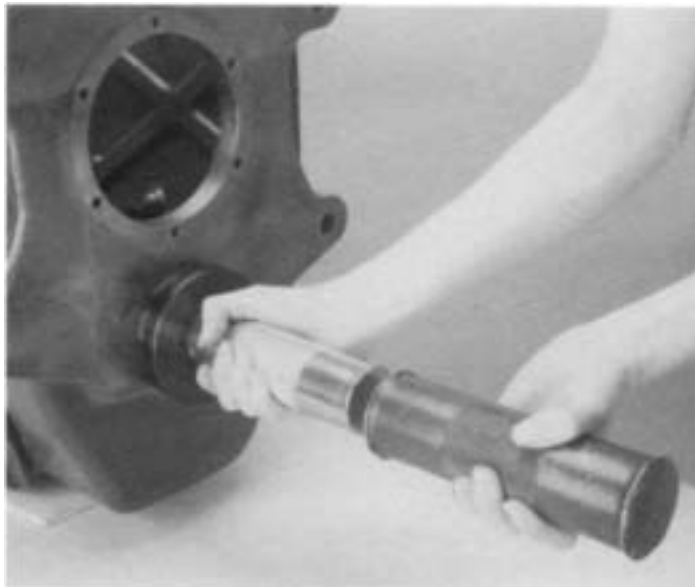

10. If previously removed, coat the outer diameter of the countershaft front bore plug with Loctite #510. Using a bearing driver, carefully drive the bore plug into the transmission case. The outer diameter bore plug lip should be even with the transmission case front. Make sure the bore plug is not cocked in the bearing bore.



12. Install a new O-ring in the reverse idler shaft O-ring groove.

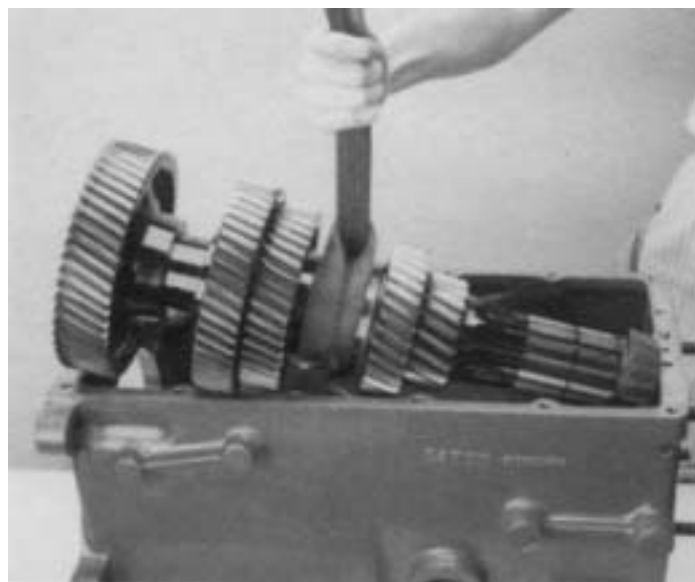

11. Carefully lower the countershaft assembly into the case. Do not seat the countershaft in the front bearing race. Let the rear of the countershaft extend out the countershaft rear bearing bore, to aid in the installation of the reverse idler gear.

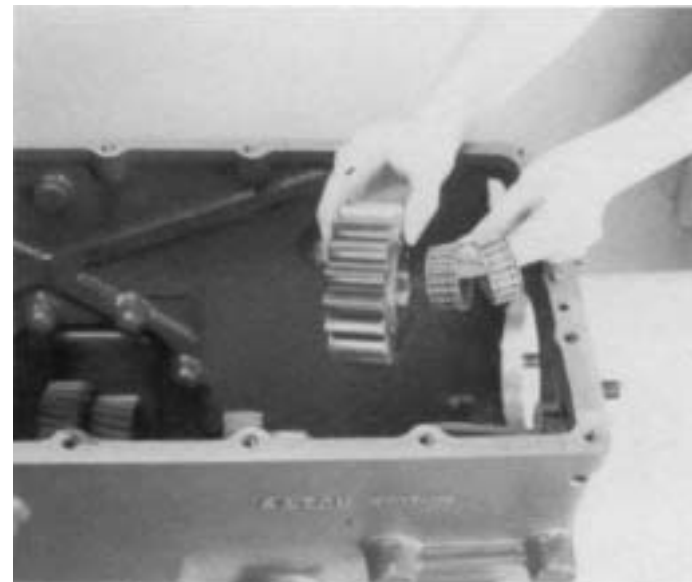

13. Install the reverse idler gear bearings in the I.D. of the reverse idler gear.

REASSEMBLY - TRANSMISSION

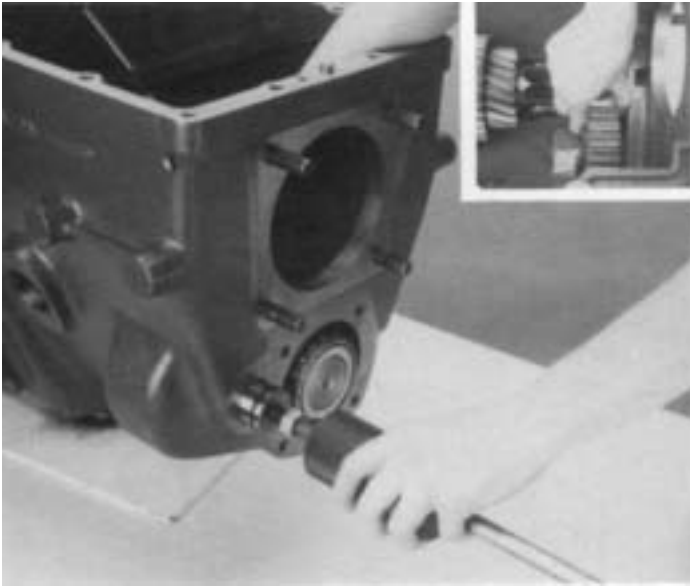

14. Position the reverse idler gear assembly in the case (inset). Insert the reverse idler shaft through the case and center of the reverse idler assembly. Using a slide hammer drive the reverse idler shaft into the case until the shaft is flush with the case rear.



16. Temporarily install new shims into the countershaft rear bearing bore.

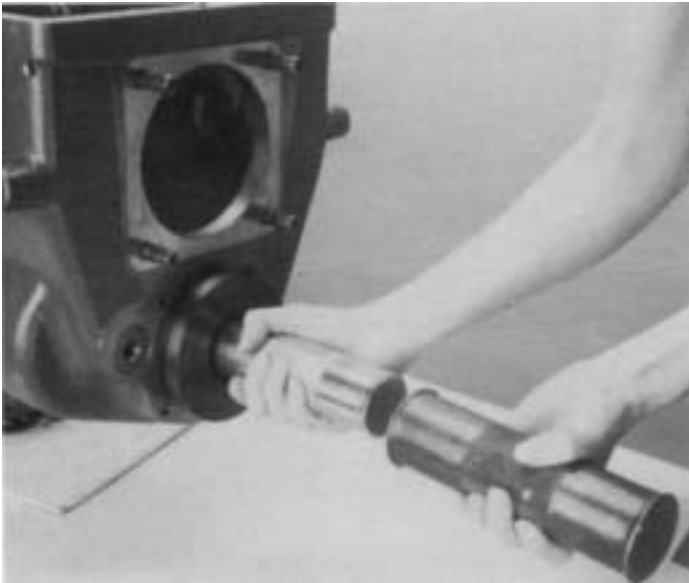

15. Install the countershaft in the front bearing race. Using the proper bearing driver install the countershaft rear outer bearing race into the case until it seats in the case bore.



17. Install a new O-ring in the countershaft rear bearing retainer O-ring groove.

REASSEMBLY - TRANSMISSION

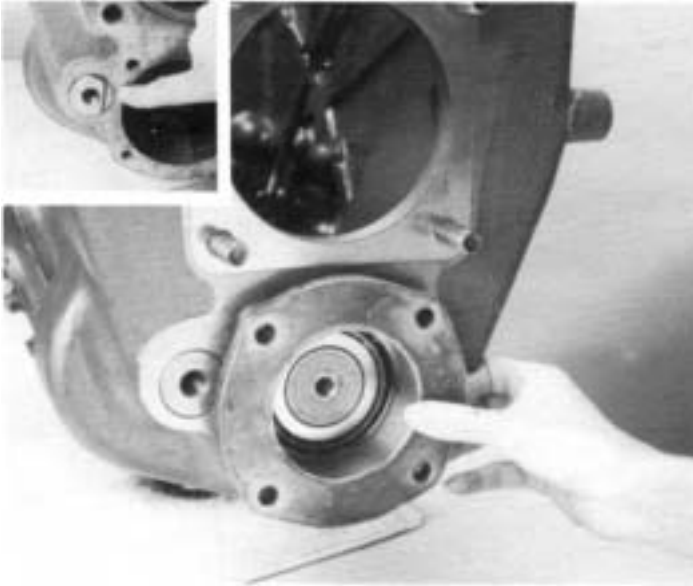

18. Temporarily install the countershaft rear bearing housing. **Note:** Align notch in rear of idler shaft in a vertical position towards bearing cover (inset).

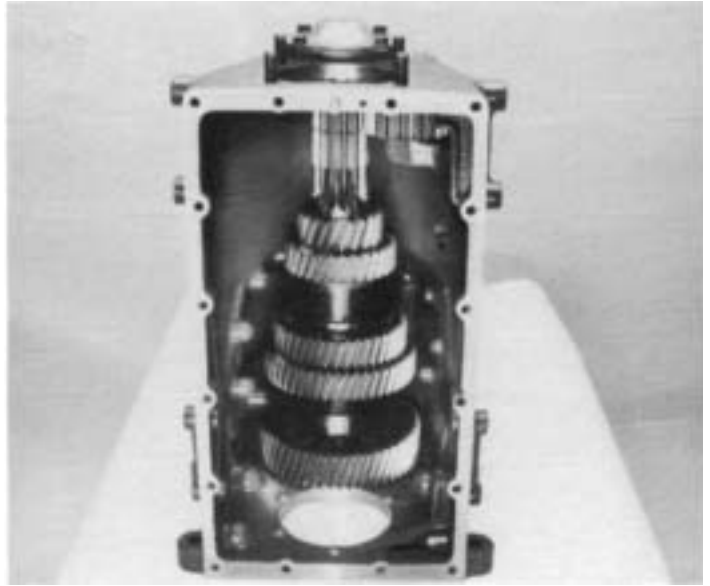

20. Turn the transmission case on end as shown.

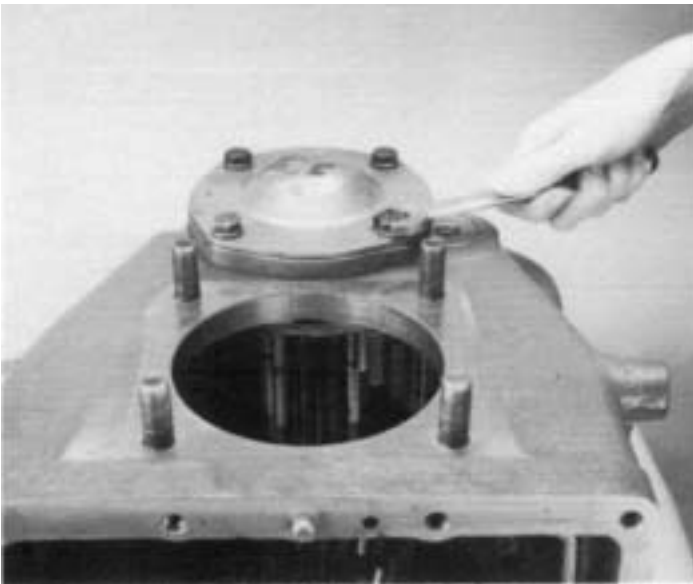

19. Temporarily install the cover gasket, countershaft rear bearing cover and four retaining capscrews. Tighten the capscrews to the recommended torque.

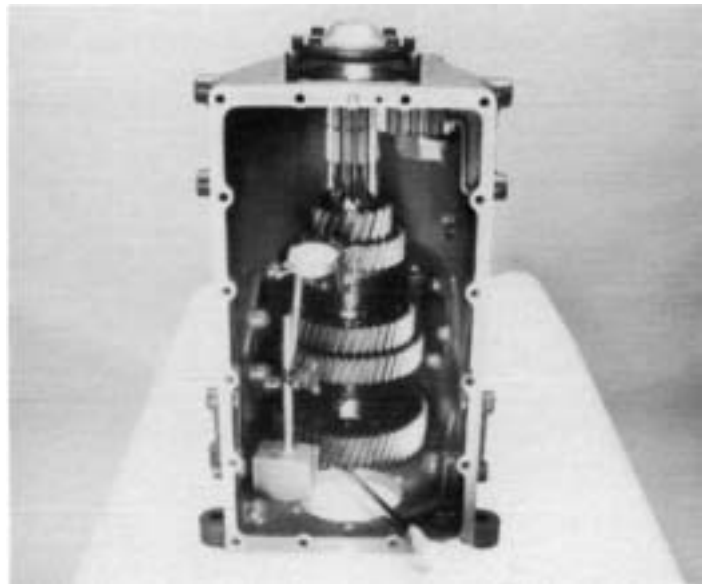

21. Rotate the countershaft 6 times clockwise and 6 times counterclockwise to seat the countershaft bearings and races. Position a dial indicator on a countershaft gear. Using a screwdriver lift the countershaft to measure the countershaft end play. Countershaft end play must be set at .006-.012 (.015-.030 mm). Add shims for increased end play and remove shims to decrease end play.

NOTE: Once countershaft end play is correctly set remove the countershaft retaining capscrews, countershaft rear bearing cover, cover gasket, the countershaft rear bearing housing and the countershaft rear bearing shims. Apply a light coat of Loctite 510 to both sides of countershaft shims and the face of the countershaft rear bearing housing.

REASSEMBLY - TRANSMISSION

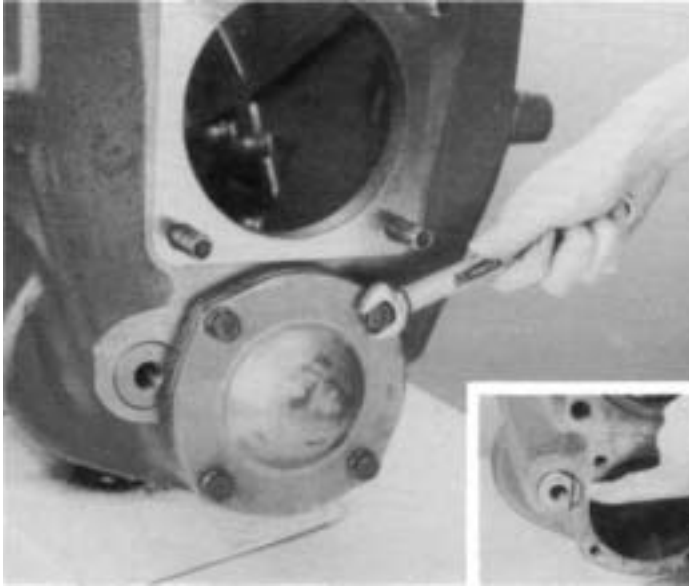

22. Align notch in rear of idler shaft in a vertical position towards rear bearing cover (inset). Reinstall the countershaft rear bearing, shims, countershaft rear bearing housing, cover gasket, countershaft rear bearing cover, and four retaining capscrews. Tighten the capscrews to the recommended torque.

REASSEMBLY - TRANSMISSION

B. Reassembly and Installation of the Mainshaft Assembly

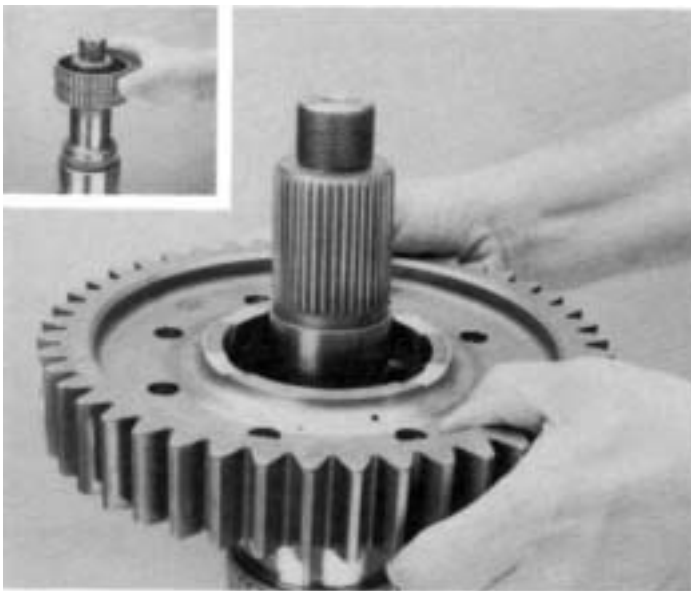

1. Install the mainshaft in a vise equipped with wood or soft jaws, mainshaft rear facing up. Lubricate and install 1st speed gear bearings (inset). Install 1st speed gear with clutching teeth facing down.

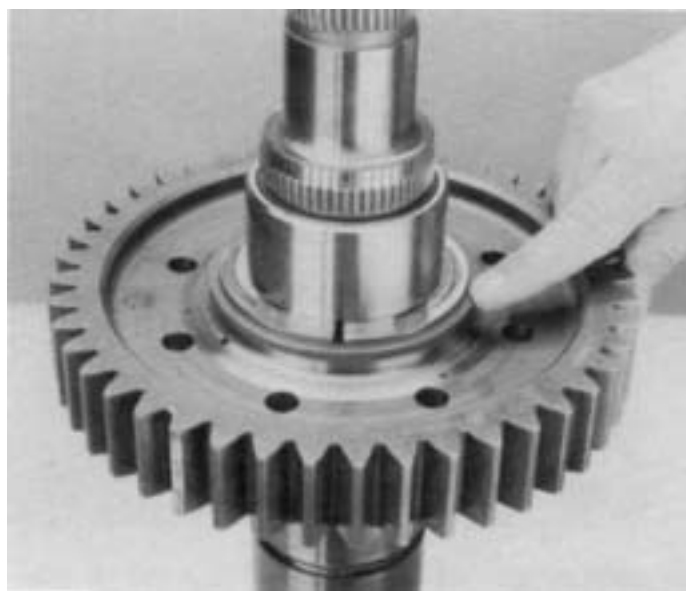

3. Install the split washer retaining ring over the split washers.



2. Install the two split washers in groove of mainshaft, aligning the internal tangs of the split washers with the machined slot in the groove of the mainshaft.

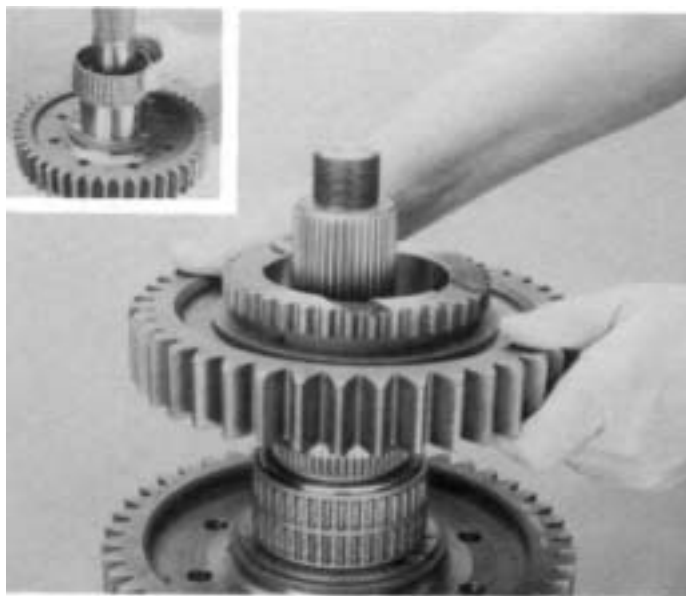

4. Lubricate and install the reverse gear bearings on the mainshaft (inset). Install mainshaft reverse gear on the mainshaft with clutching teeth facing up.

REASSEMBLY - TRANSMISSION



5. Install the reverse gear clutch hub on the mainshaft, with the tapered threaded end facing up.

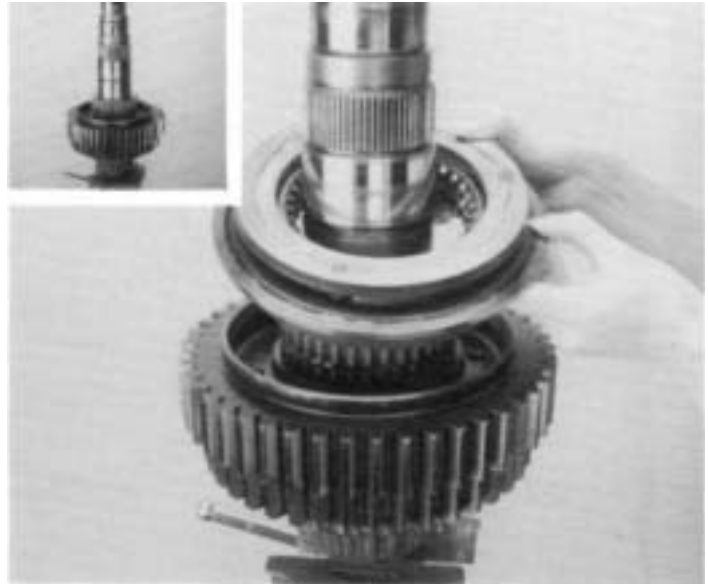

7. Reposition the mainshaft in the vise with the mainshaft front facing up. Lubricate the mainshaft 1st - 2nd speed synchronizer rings and install the 1st - 2nd speed synchronizer with the synchronizer ring marked FRONT facing up.



6. Using a heat lamp or hot plate and oil, heat the mainshaft rear tapered bearing and install the tapered bearing on the mainshaft as shown. Make sure the bearing is seated on the reverse gear clutch hub.

NOTE: DO NOT HEAT THE TAPERED BEARING ABOVE 275°F (136°C).



8. Lubricate and install the 2nd speed bearings (inset). Install the 2nd speed mainshaft gear on the mainshaft with clutching teeth facing down.

REASSEMBLY - TRANSMISSION

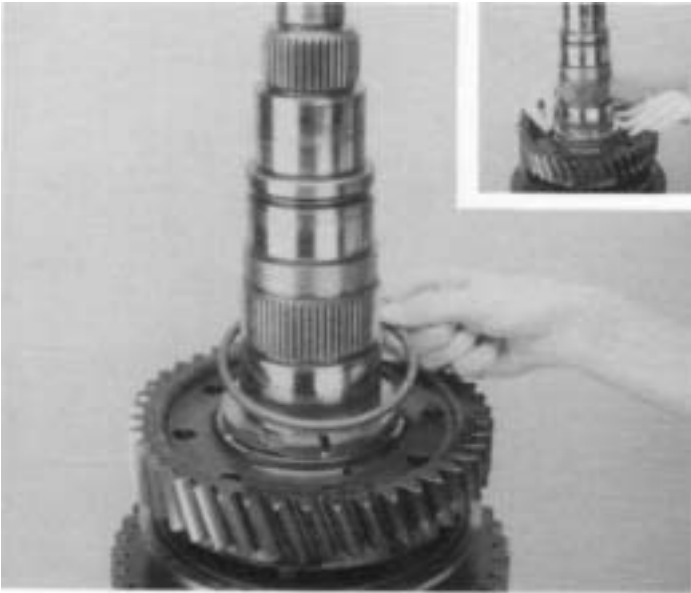

9. Install the two split washers in the mainshaft split washer grooves (inset). Install the split washer retaining ring over the split washers.



11. Lubricate the 3rd-4th speed shift hub and install the shift hub on the mainshaft splines with the flat side of the shift hub facing up.

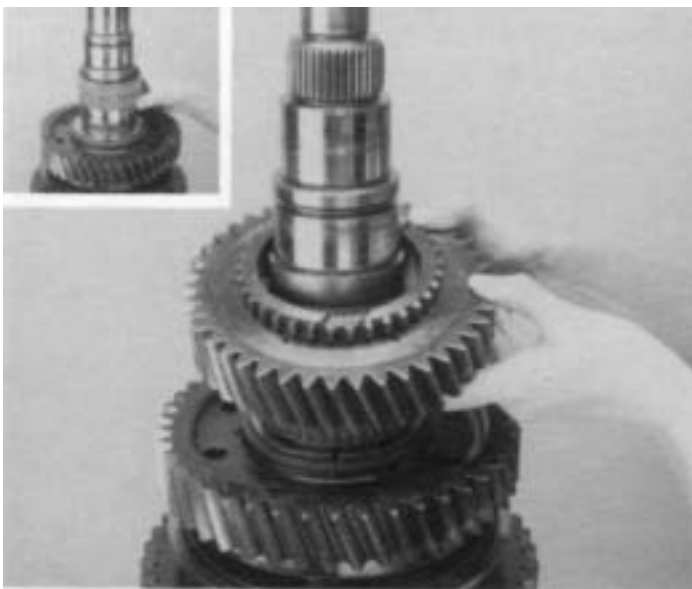

10. Lubricate and install the mainshaft 3rd speed bearings on the mainshaft (inset). Install mainshaft 3rd speed gear on the mainshaft clutching teeth facing up.



12. Install the 3rd-4th speed shift hub retaining snap ring in the mainshaft snap ring groove.

REASSEMBLY - TRANSMISSION

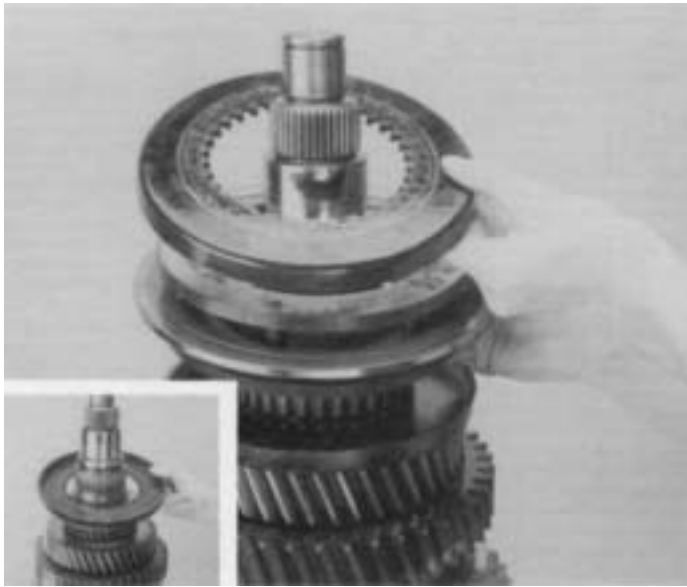

- 13.** Lubricate and install the 3rd speed synchronizer cup on the mainshaft (inset). Lubricate and install the 3rd - 4th speed synchronizer and synchronizer cup, synchronizer ring identified FRONT facing up.

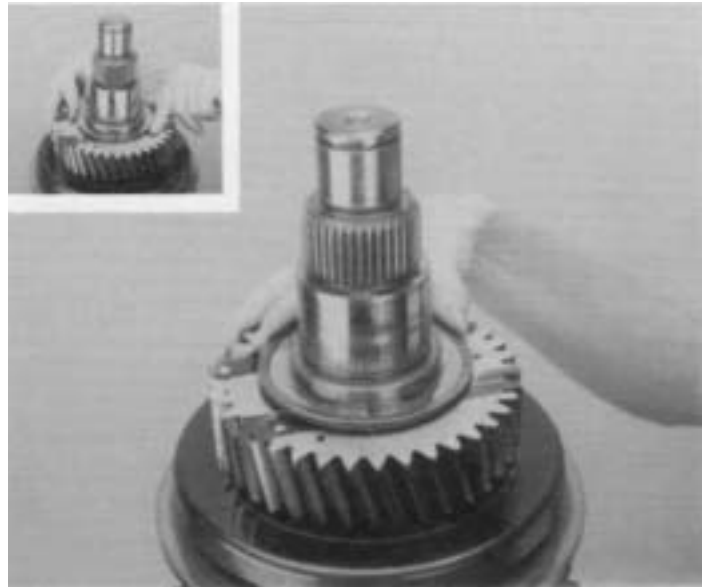

- 15.** Install the two split washers in the mainshaft split washer grooves (inset). Install the split washer retaining ring over the split washers.



- 14.** Lubricate and install the 4th speed bearings on the mainshaft (inset). Install the 4th speed gear on the mainshaft clutching teeth facing down.

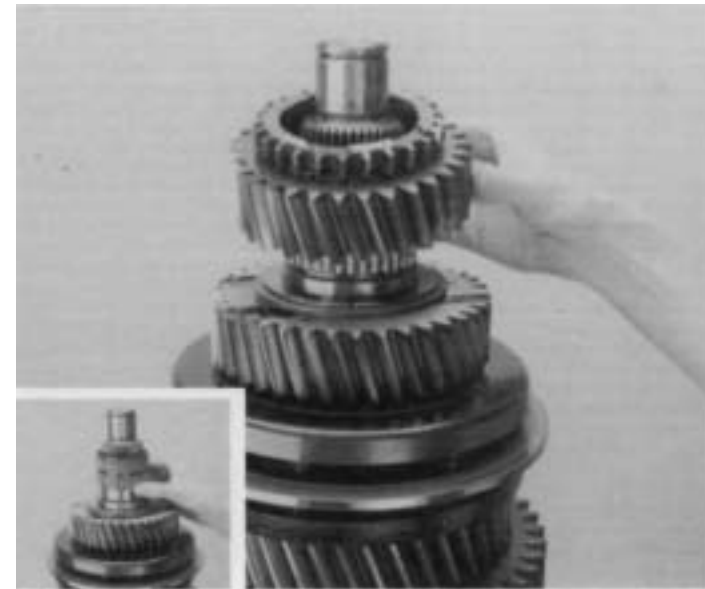

- 16.** Lubricate and install the 5th speed bearings on the mainshaft (inset). Install 5th speed gear on the mainshaft clutching teeth facing up.

REASSEMBLY - TRANSMISSION

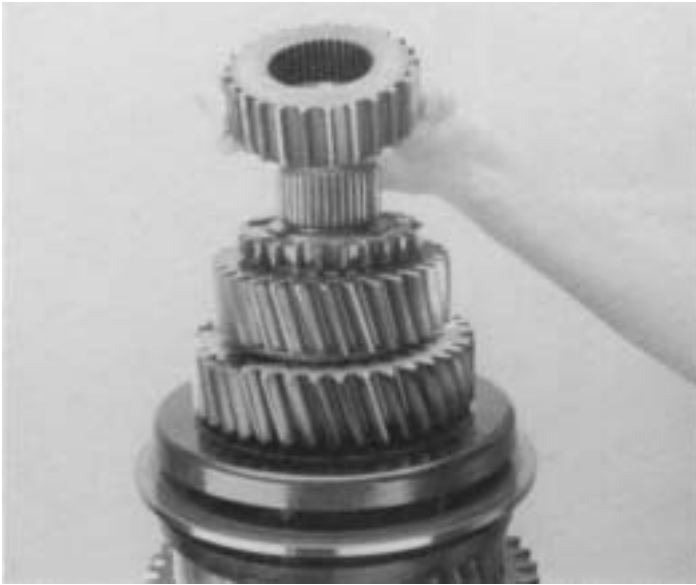

17. Install the 5th-6th speed clutch hub on the mainshaft splines with flat surface facing up.



19. Lubricate and install the 5th-6th speed synchronizer cups and synchronizer ring identified FRONT facing up.

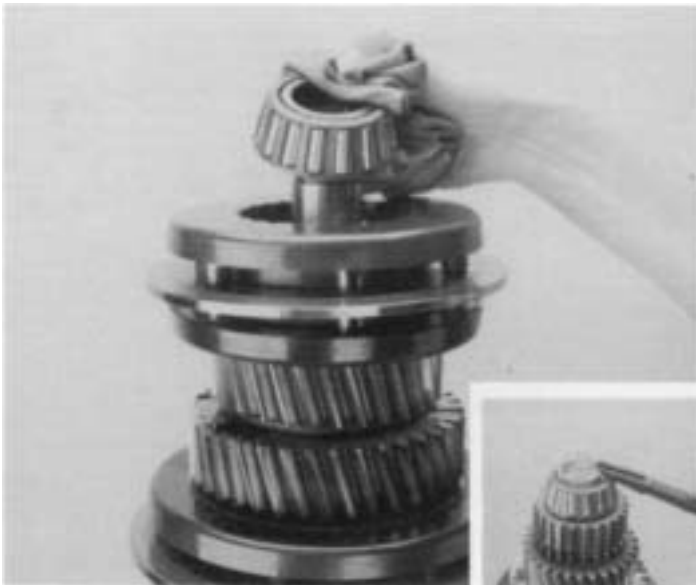

18. Using a heat lamp or hot plate and oil, heat the mainshaft front tapered bearing and install the tapered bearing on the mainshaft as shown. Make sure the bearing is seated then install the mainshaft bearing retaining snap ring in the mainshaft snap ring groove (inset).

Note: Do not heat the tapered bearing above 275°F (136°C).

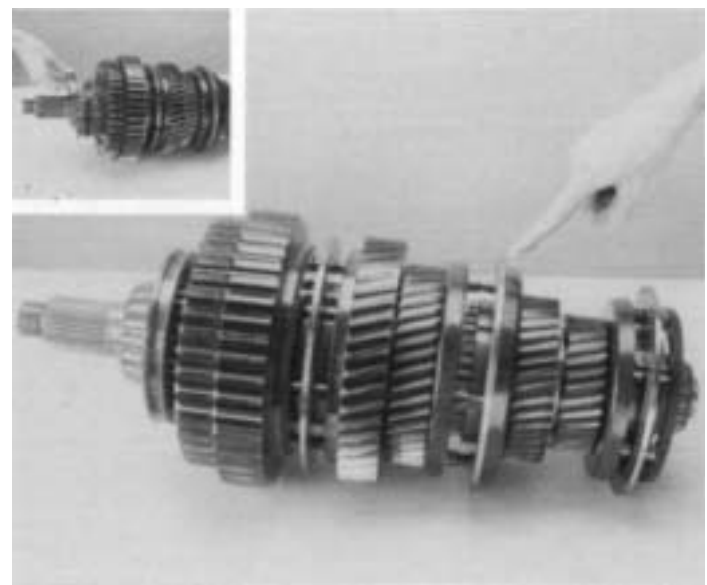

20. Remove the mainshaft assembly from the vise and place the assembly on a bench, install the reverse gear sliding clutch (inset), and shift the 3rd-4th speed synchronizer into 4th speed gear position.

REASSEMBLY - TRANSMISSION

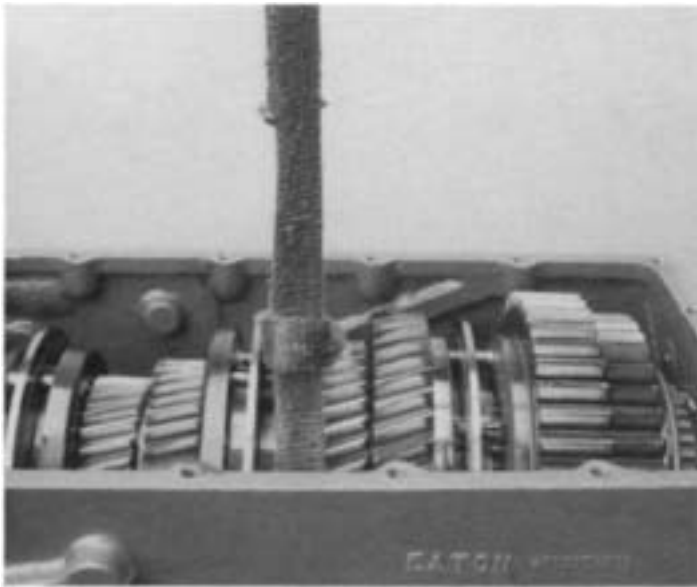

21. Using a sling around the 3rd-4th synchronizer carefully lower the mainshaft assembly into the case. Remove the sling and place the 3rd-4th synchronizer in neutral.

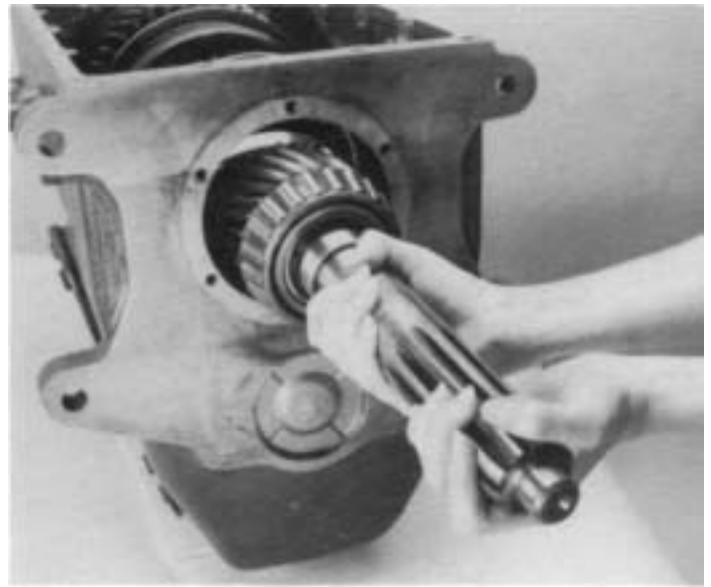

23. Install the input shaft by aligning the clutching teeth on the 5th-6th speed synchronizer and input shaft clutching teeth.

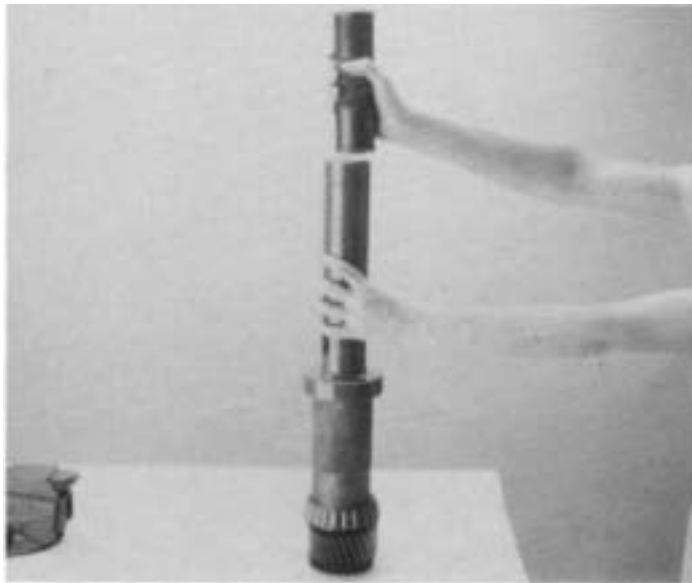

22. Using the proper size sleeve type driver install the front tapered bearing on the input shaft.



24. Coat the outer diameter of the front bearing cover oil seal with a light coat of Loctite #510. Install the oil seal with a flanged driver. Install a new input shaft bearing race in the front bearing cover (inset).

REASSEMBLY - TRANSMISSION

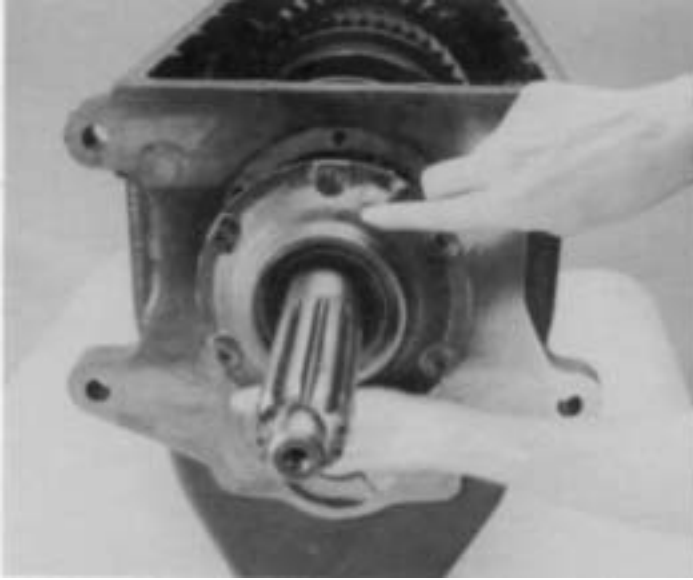

25. Install the front bearing cover and gasket, align the cover and gasket with the six capscrew holes in the case. Install the six capscrews and tighten to the recommended torque.

NOTE: The top of the front bearing cover is marked **ÖTOPÓ** for proper installation.

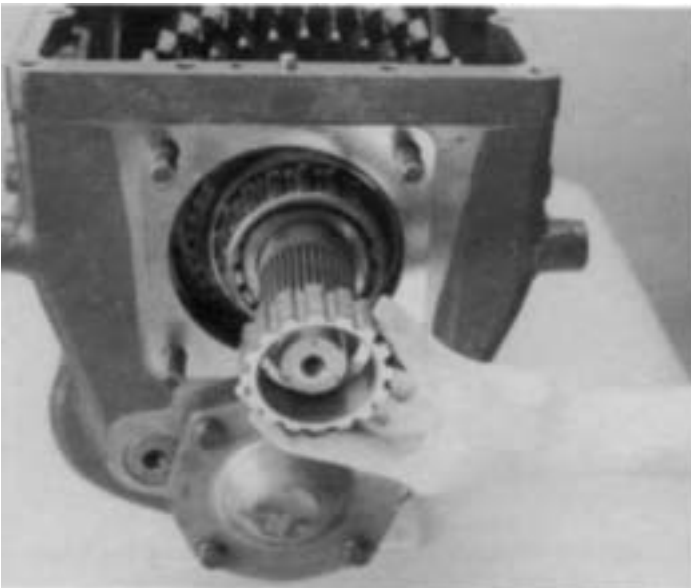

26. Install the speedometer drive or rotor on the output shaft.

REASSEMBLY - TRANSMISSION

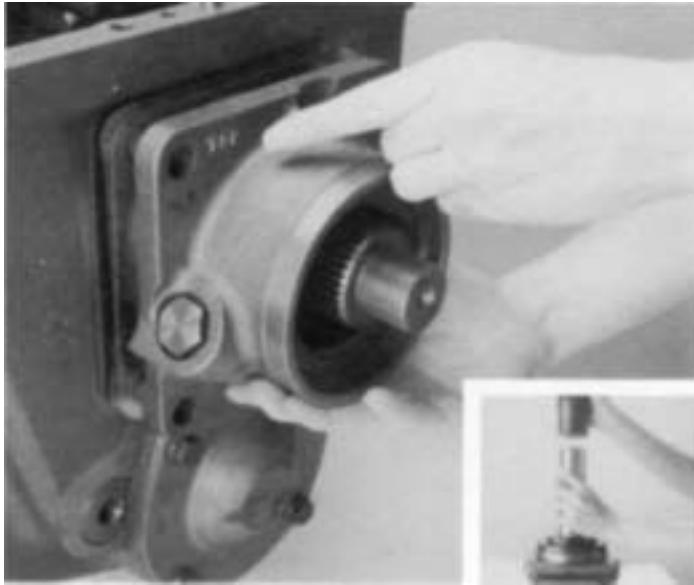

27. If necessary install rear bearing race (inset). Temporarily install shims and rear bearing cover. Tighten nuts to 60-70 lbs. ft. (81-95 Nm).

NOTE: Top of rear bearing cover is marked for proper installation,

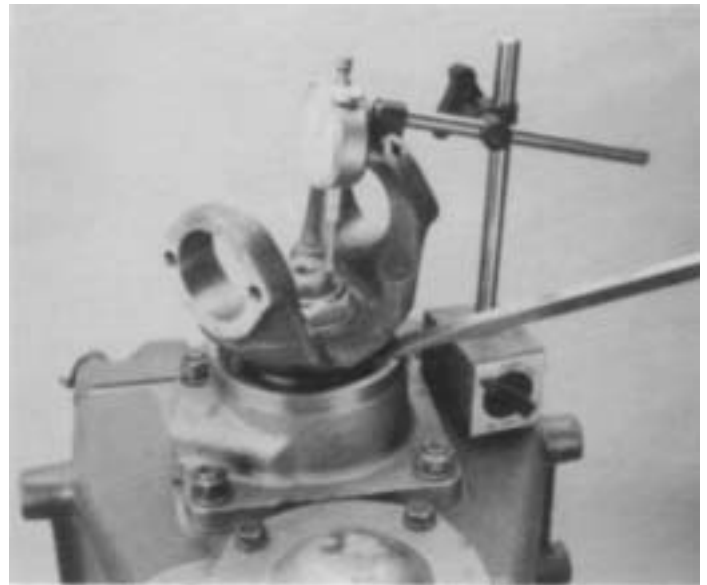

29. Position dial indicator as shown. Pry up on output shaft to measure end play. End play must be set at .006-.010 (.152-.254 mm). Add shims for more end play, remove shims for less end play.

NOTE: Once end play is correct remove yoke and rear bearing cover and apply a light coat of Loctite #510 to both sides of shims.

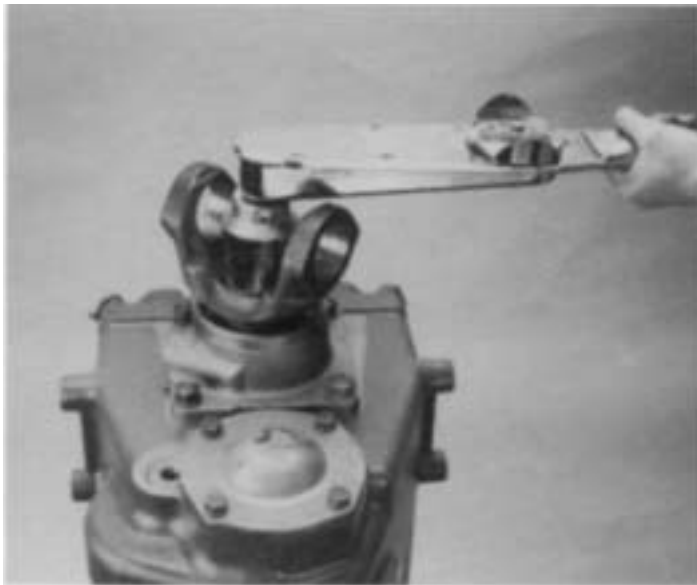

28. Place transmission in a vertical position as shown. Install yoke and nut. Torque nut to 300-350 lbs. ft. (407-475 Nm). Rotate input shaft and mainshaft to seat bearings and races.



30. Install rear seal using a flanged driver.

REASSEMBLY - TRANSMISSION

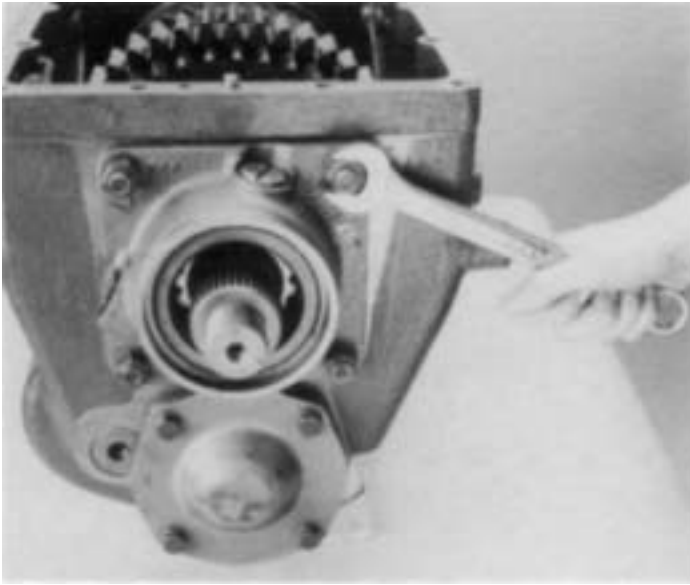

31. Install the rear bearing cover on the 4 studs in the transmission case. Install the four retaining nuts and washers, tighten to 60-70 lbs. ft. of torque.

NOTE: Top of the rear bearing cover is marked "TOP" for proper installation.

INSTALLATION - CLUTCH HOUSING AND OUTPUT YOKE

A. Installation of Clutch Housing

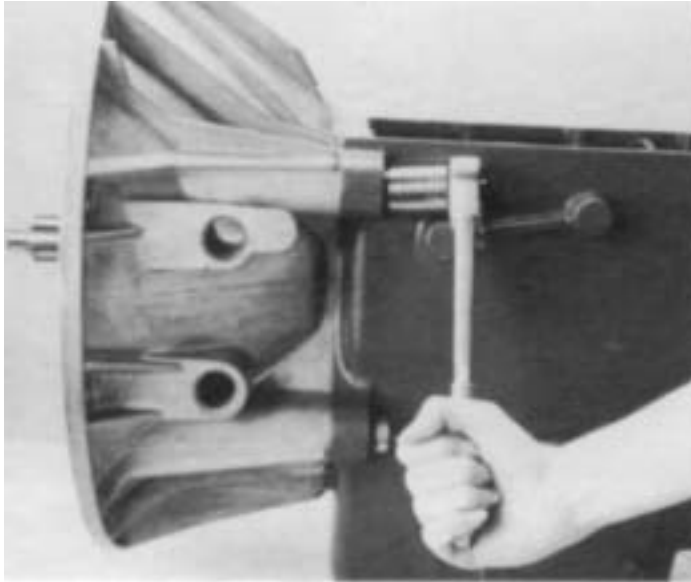

1. Position clutch housing on front of transmission. Install four retaining bolts and torque to the recommended torque.

B. Installation of Yoke

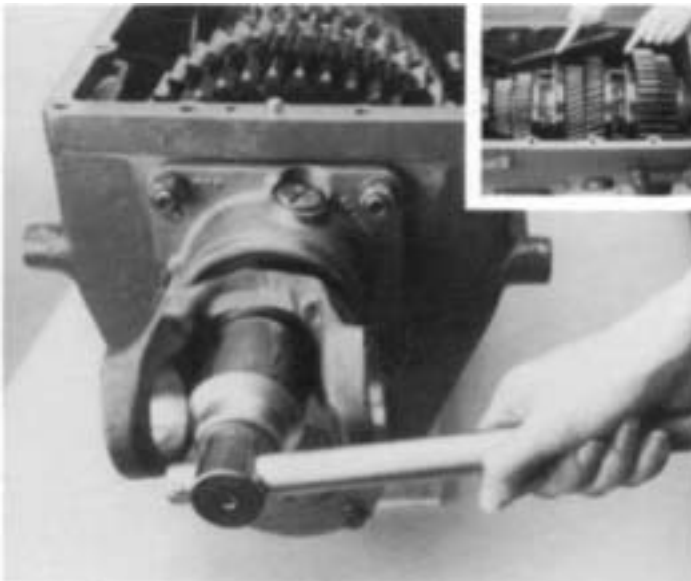

1. Lock the transmission by engaging two mainshaft gears (inset). Carefully install yoke and nut. Tighten nut to the recommended torque.

INSTALLATION - SHIFTING CONTROLS

A. Shift Bar Housing Assembly

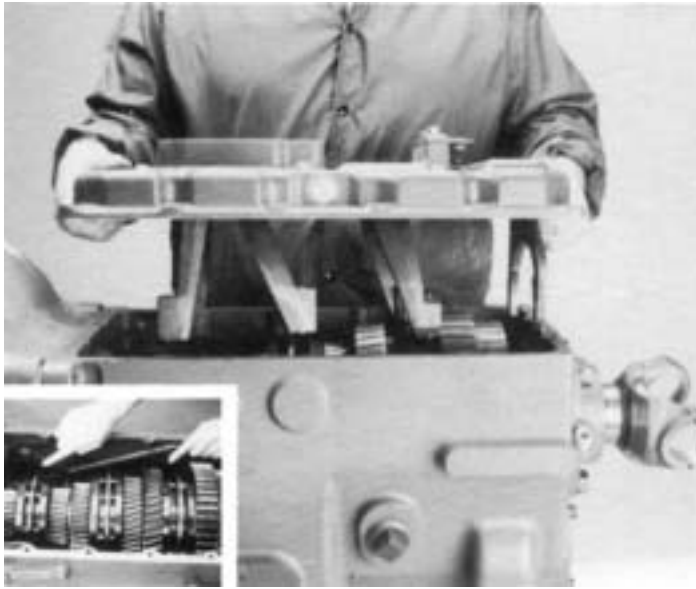

1. Place transmission in neutral (inset) and install gasket on case. Place shift bar housing in neutral and install on case making sure shift yokes align with corresponding synchronizers and sliding clutch.



2. Apply Loctite #262 to threads of cap screws. Install cap screws into housing and tighten to the recommended torque.

INSTALLATION - SHIFTING CONTROLS

B. Gear Shift Lever Housing Assembly



1. With the shift bar housing in the neutral position, install gasket and gear shift lever assembly on the shift bar housing. Fit gear shift lever in corresponding finger assembly in bar housing as lever is installed

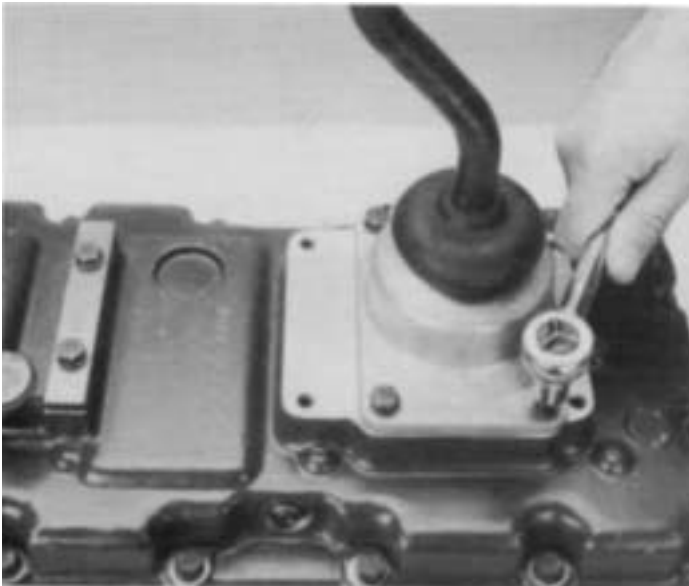

2. Coat threads of retaining cap screws with Loctite #262 and install. Torque cap screws to 20-25 lbs. ft. (27-34 Nm).

Copyright Eaton Corporation, 2012. Eaton hereby grant their customers, vendors, or distributors permission to freely copy, reproduce and/or distribute this document in printed format. It may be copied only in its entirety without any changes or modifications. THIS INFORMATION IS NOT INTENDED FOR SALE OR RESALE, AND THIS NOTICE MUST REMAIN ON ALL COPIES.

Note: Features and specifications listed in this document are subject to change without notice and represent the maximum capabilities of the software and products with all options installed. Although every attempt has been made to ensure the accuracy of information contained within, Eaton makes no representation about the completeness, correctness or accuracy and assumes no responsibility for any errors or omissions. Features and functionality may vary depending on selected options.

For spec'ing or service assistance, call 1-800-826-HELP (4357) or visit www.eaton.com/roadranger. In Mexico, call 001-800-826-4357.

Roadranger: Eaton and trusted partners providing the best products and services in the industry, ensuring more time on the road.

Eaton Corporation

Vehicle Group
P.O. Box 4013
Kalamazoo, MI 49003 USA
800-826-HELP (4357)
www.eaton.com/roadranger

Printed in USA